

piFLOW®

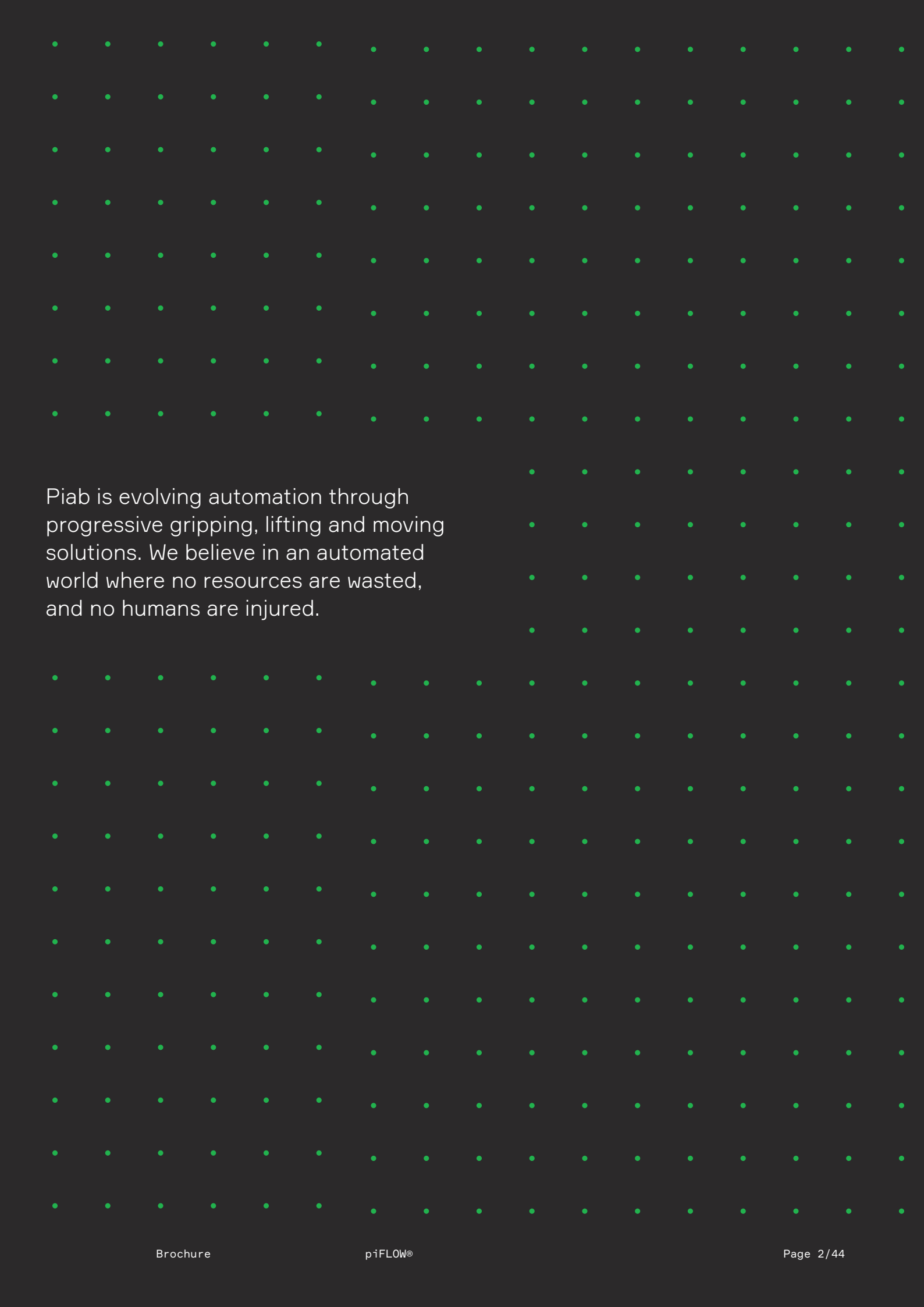

Customized solutions by modular design



Piab is evolving automation through progressive gripping, lifting and moving solutions. We believe in an automated world where no resources are wasted, and no humans are injured.

Index

Overview	4
The Principle of Vacuum Conveying	6
COAX® Technology	8
System solutions	10
piFLOW® Conveyors	12
piFLOW® _p SMART	14
piFLOW® _p	18
piFLOW® _t	20
piFLOW® _{fc}	22
piFLOW® _f	24
piFLOW® _i	26
Industries	28
Food and Beverage	30
Pharmaceuticals	32
Chemical	34
Additive Manufacturing	36
Accessories and Spare parts	38

Overview

Integrate 70 years of global vacuum experience into your solution

With more than 70 years of global experience, we are the leader within vacuum conveying technology. Access the global expertise of Piab!

Piab's products are made to be used in industries such as food, pharmaceutical, chemical, and more. Our vacuum conveyors help to better automate and evolve your core business.

Piab's vacuum conveyors are all designed through a modular program based on standard components. This gives you the possibility to convey a wide range of different products, still with a limited number of standard modules. Hence, you can depend on the piFLOW® being available with a short delivery time allowing you to get started now.



Less energy consumption



Short delivery time



Instant document access



Easy to integrate

To simplify the process, we give you access to our unique web interface where you can configure your product and download relevant documentation e.g. CAD files, datasheets, manuals etc. This gives you the benefit of being in control of your projects in an easy way.

With our worldwide sales offices, we offer support every step of the way in order to help you grow your business.

Features overview

Product name	Segment	Capacity	Industry 4.0 ready	Sizes	Certifications
piFLOW®p SMART	Food, Chemicals, Pharma	5 tons/hrs [11,000 lbs/h]		5 - 33 liter	FDA ¹ USDA ²
piFLOW®p	Food, Chemical, Pharma, AM ³	14 tons/hrs [30,000 lbs/h]		2 - 56 liter	FDA ¹ USDA ²
piFLOW®t	Food, Pharma	2-3 milion parts/h ⁴		10 liter	FDA ¹ USDA ²
piFLOW®fc	Food, Chemical	8 tons/h [17,000 lbs/h]		3 - 33 liter	FDA ¹ USDA ²
piFLOW®f	Food	7.5 tons/h [16,000 lbs/h]		6 - 28 liter	FDA ¹
piFLOW®i	General industry	7.5 tons/h [16,000 lbs/h]		6 - 28 liter	

¹ All materials in contact with the conveyed product fulfill the requirements of FDA. ² piFLOW®p/t is designed according to USDA dairy guideline. ³ Additive Manufacturing ⁴ Parts e.g. chewing gums, candy, capsules



Reduce product scrap and contamination

When using a vacuum conveyor you are working with an enclosed system where no foreign material will be mixed in and no product will fall off the sides into the surrounding area. It is also a very gentle way of transporting the product, meaning that the product will be intact throughout the whole transportation process and will not be damaged. The velocity is adjusted depending on the fragility of the product – eliminating product scrap.

Small footprint

The vacuum conveying solution has a small footprint since the tubing can go strictly vertical from the point of suction. The tubing is normally mounted in level with the discharge point and therefore not in conflict with other equipment. This means that the floor space can be utilized in a more cost-efficient way.

Furthermore, if the production layout is to change in the future, where for example new equipment will be added, a vacuum conveyor will fit the new layout without modifications or costly investments.

Minimize maintenance

Piab's vacuum conveyors have very few moving parts, so that the service and maintenance cost is kept at a very low level without needing to compromise on the reliability of the system. You can disassemble the conveyor body without using tools. The pump unit is designed with a separate vacuum module that can easily be removed for cleaning, resulting in reduced downtime.

Vacuum conveying is a modern way of transporting powders and granules with a number of benefits.

Safe working environment

When comparing with mechanical conveying systems such as screw and belt conveyors another important advantage of the vacuum conveying is a dust-free working environment. As vacuum conveying is an enclosed system you will be able to improve the working environment, and it will also give you the capability to convey materials that are hazardous.

The Principle of Vacuum Conveying



The principle

Vacuum is created with compressed air through COAX® technology or mechanical pumps (not shown in picture) (1). The bottom valve (2) closes and the vacuum in the container (3) and the conveying line (4) increases. The product is carried away from the feed station (5) into the conveying line and then to the container.

During the whole conveying process the filter (6) protects the pump and the surrounding area from dust and small particles, and the air shock tank (7) is filled with compressed air.

At a preset or automatic time, the pump and the conveying are stopped and the bottom valve (2) is opened. The product is discharged at the same time as the air shock is activated and the compressed air cleans the filter from dust and small particles.

When the pump starts again, this process is repeated and a new cycle starts. The suction time and emptying times are normally controlled by a pneumatic control, an electric control system or completely automated with the new SMART systems.



“We have some of the most knowledgeable application engineers for Vacuum Conveying Technology in the world, running 11 test labs in 4 continents.”

Floris Rouw
President Vacuum Conveying Division

Conveyors for every need

The modular design makes it possible to convey efficiently with a small footprint. Production capacity ranges from few kg/h [lb/h] to 15 tons/h [30,000 lb/h] and up to +60 meters [or +200 feet] in conveying distance together with high vertical lifts up to 20 meter [65.5 feet].

- **Modular and flexible design makes it easy to adapt and create an efficient conveying system**
- **Modular system allows you to choose the size needed for a suitable batch volume**
- **Our conveyors can convey material with a particle size 0.5 µm up to 30 mm**
- **Our conveyors can convey materials with a bulk density between 0.1 g per liter and 9kg per liter (or up to 560 lb per cu ft)**
- **Fluidization helps emptying the conveyor when having a bridging material**

Production flexibility

By replacing just a few parts of the modular vacuum conveying solution, one can easily change the configuration to increase conveying distance, change the equipment layout or enhance the system capability and capacity with minimal cost. This gives flexibility for expansion without compromising the reliability of the system.

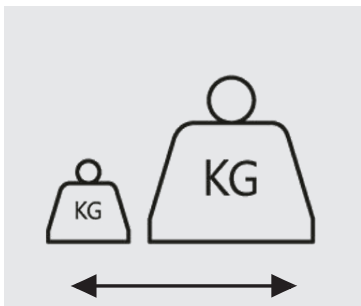

Conveys materials with a bulk density between 0.1 gram and 9 kg [20 lbs] per liter

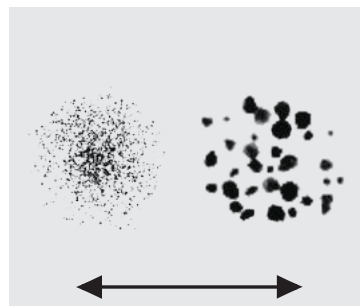

Size of material from 0.5 µm to 30mm

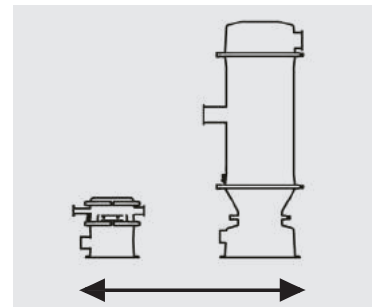

Batch volume of 2 to 56 liter

COAX[®] Technology

COAX[®] cartridges are based on advanced technology for creating vacuum with compressed air. They are smaller, more efficient and more reliable than conventional ejectors, which allows for the design of a flexible, modular and efficient vacuum system.

A vacuum system based on COAX[®] technology provides three times more vacuum flow than conventional systems, while reducing energy consumption.

As independent comparative tests at the Fraunhofer Institute for Machine Tools and Forming Technology IWU in Dresden have shown, Piab's COAX[®] ejectors work twice as fast as other ejectors and deliver three times more flow than conventional ejectors with identical air consumption. This allows the pump unit to perform well even with low or fluctuating supply pressure and is particularly energy efficient.



Less energy consumption



Increased air flow



More efficient

stream of compressed air. Suction will be generated at the opening of each stage (3), resulting in vacuum.

COAX[®] combines the internal components of a multi-stage vacuum pump into a single vacuum cartridge. The result is a smaller, more efficient and more reliable vacuum technology.

Piab uses the COAX[®] principle in two series of vacuum pumps. The piBASIC pump, used with the piFLOW[®]i and piFLOW[®]f conveyors, and the piPREMIUM pump, used with piFLOW[®]p as well as piFLOW[®]fc conveyors.

Both use our unique, high efficiency multi-stage, vacuum generator technology to drive the vacuum conveying process.

The principle

When compressed air (1) passes through the nozzles (2), air is pulled through with the

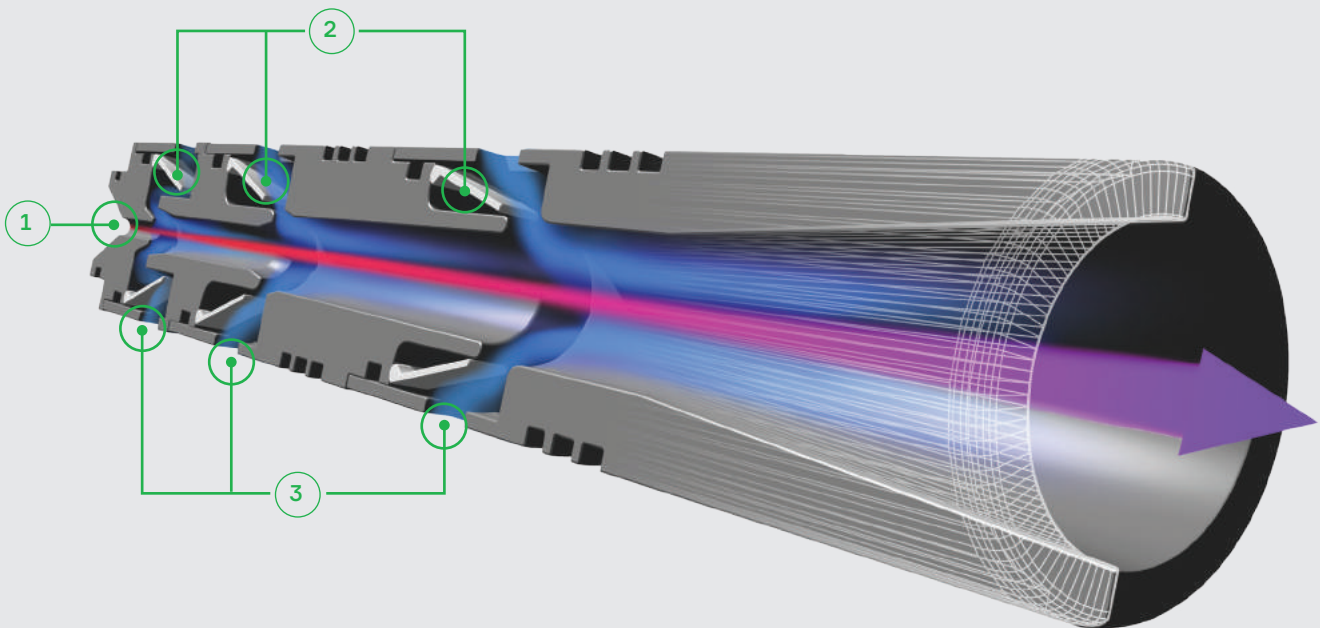

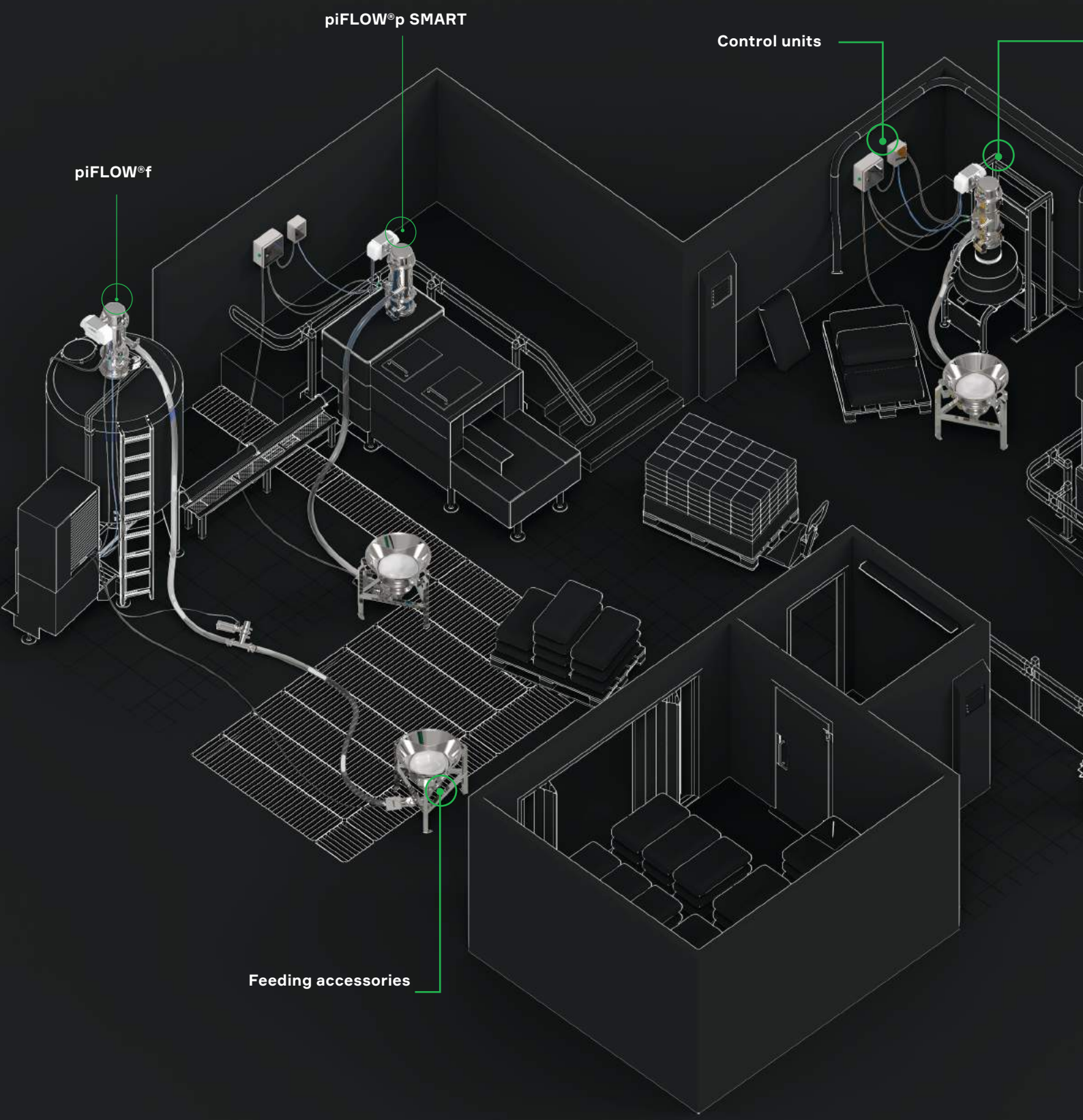

piFLOW[®]f

piFLOW[®]p SMART

Control units

Feeding accessories

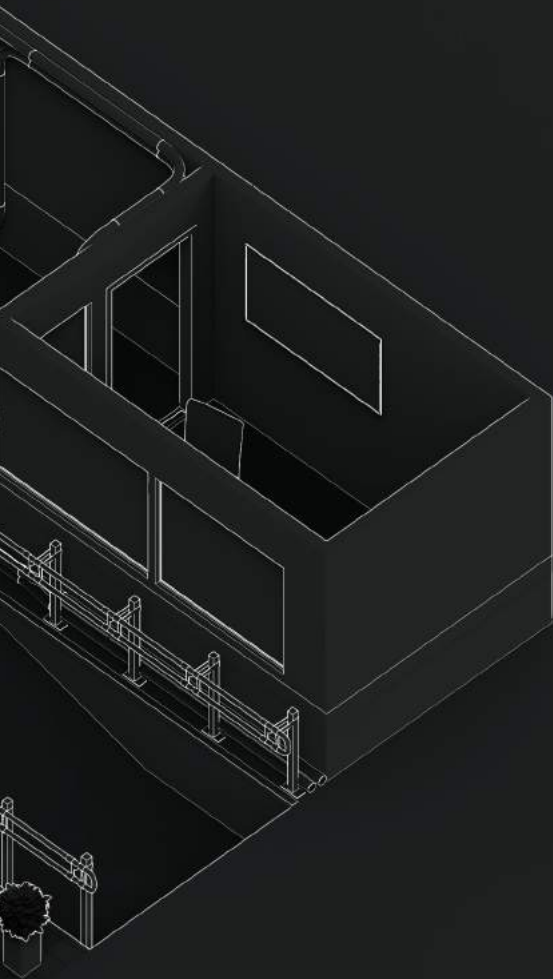

System solutions

piFLOW®p SMART is our smartest product offering, taking vacuum conveying to a new level, fully automated with optimised throughput.

piFLOW®p for applications with high demands or product contact areas, such as pharmaceutical industry, or when ATEX certified systems are required. Specifically designed for quick and simple dismantling for easy cleaning of equipment.

piFLOW®t for applications with the need of conveying fragile products. piFLOW®t is designed to fulfil the needs through controlled low speed conveying of the product and guided entry of the product, together with elimination of all the sharp edges in the entire product flow. Product flow can be easily adjusted through the innovative piGENTLE® functionality.

piFLOW®fc is specialized for conveying powder and granules in the food industry. It is designed to meet high requirements of food industry related to hygiene, safety, and process accuracy, but not requiring the need for acid-resistant stainless steel.

piFLOW®f is for applications with less demands on acid resistance. Designed with a Stainless Steel (ASTM 304) body and seals that come in contact with the product. This is in compliance with FDA to meet the demands of industrial food grade applications.

piFLOW®i is widely used in the chemical industry for conveying powder and granules. This conveyor is often used as an alternative to mechanical conveyors when there is a requirement for dust free conveying.

Control units control the functions of the conveyor. Piab offers a range of control units from simple pneumatic controls to advanced electric, software based control units.

Feeding accessories provide an optimized feeding point and ensure maximum capacity and safe transport.

When producing food, pharmaceuticals and chemical products there are demands on the highest possible degree of safety as to hygiene and operation. Piab's piFLOW® conveyors have been developed as an answer to the strict requirements of operational safety and hygiene in the food, pharmaceutical, chemical industries and additive manufacturing.

piFLOW® Conveyors

piFLOW[®]p SMART

Takes conveying to the next level

With each new conveying cycle, the piFLOW[®]p SMART will prove its name, using machine learning to automatically tune the process by configuring and optimising a flawless flow of materials, set at the correct rate.

piFLOW[®]p SMART is a complete system. It has a heart, a brain and senses. At its heart (1), vacuum is created with compressed air and Piab's COAX[®] technology. The system's brain, the Electrical Control Unit (2), automatically controls the pump. It does so with the help of its Valve Unit (3) where vacuum and pressure are being sensed, and electrical signals converted into pneumatic ones.

Powder, grains or granules are carried from the feed-point (4) through the Air Carrying Unit (5) and the conveying line to the container (6) when the bottom valve (7) is closed. When the conveyor is full, the top sensor (8) is activated, stopping the pump and opening the bottom valve. The material is discharged at the same time as a shock of compressed air cleans the filter (9). The bottom level sensor (10) is



Less energy consumption



Operator skills independent



User friendly

Certifications



deactivated, closing the bottom valve and starting the pump. And so the next conveying cycle begins!

- In compliance with FDA, EC No. 1935/2004 and EU No. 10/2011
- Steel quality ASTM 316L (stainless steel, acid resistant)
- Quick installation and start-up as a result of pre-configured conveying settings

The piFLOW[®]p SMART is a stand-alone system with machine learning software and sophisticated algorithms that run the application to reach the maximum capacity for the conveyed material.

Features overview

Material	Temperature	Weight	Feed pressure		
			Max.	Range ¹	Control range
ASTM 316L, NBR, ePTFE, PET, PA, Al, SS, PP	5 - 50 °C 41 - 122 F	43 - 95 kg 95 - 209 lbs	0.7 MPa 102 psi	0.4 - 0.6 MPa 58 - 87 psi	0.4 - 0.6 MPa 58 - 87 psi
Air consumption	Vacuum	Noise level	Filter area	Particle size	Batch volume
5 - 84 NI/s 10.5 - 178 scfm	60 - 75 -kPa 18-22.2 -inHg	69 - 77 dBA	0.09 - 3 m ² 1 - 32 ft ²	min. 0.5 µm	5 - 33 l 0.18 - 1.17 ft ³

¹ Our recommended range of feed pressure

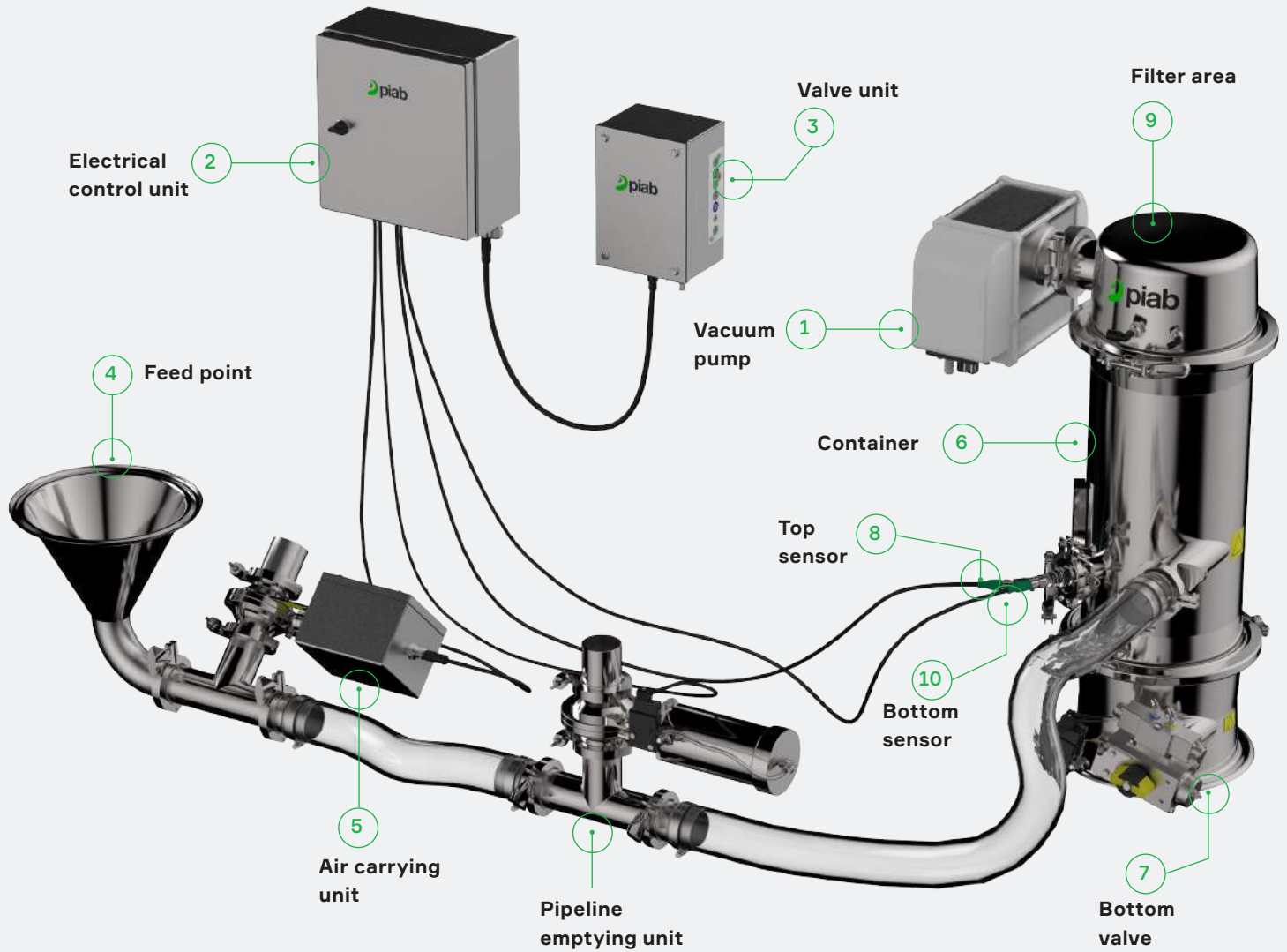

Pipeline emptying unit

In pipelines with a vertical lift of between 8 and 25 meters (or between 25 and 80 feet), the Pipeline Emptying Unit makes sure that the conveying lines are properly emptied, preventing blockages. Clearing vertical pipeline sections at the end of each suction cycle is a procedure that adjusted by the electrical control unit.

Level sensors

Calibrated and optimized for each conveyed material, strategically placed level sensors guard against overfilling and monitor the process. No need for manual timer settings for starting/stopping the pump or opening/closing the bottom seal. In each cycle, sensors are cleaned by a shock of air, ensuring long life and optimal function.

Air carrying unit

The carrying air ratio is automatically set and continuously adjusted during the entire cycle using machine learning in the integrated Air Carrying Unit. Eliminating the need for feed adapter tuning, this guarantees optimal transportation of materials and ensures applications run at best possible capacity.



Do you want to know more?

Take a look at the online product page: www.piab.com

piFLOW[®]p SMART

Changes that would normally take one hour in a conventional vacuum conveyor takes only 10 minutes in piFLOW[®]p SMART. That's why we call it the Changeover Champion!

Six times faster

The perfect performance and productivity promoter, piFLOW[®]p SMART is the world's first self-optimising vacuum conveyor. Integrated with smart software and sensor technology, it is the ultimate choice for processors handling many different materials or those that need to make frequent changes.

Proving its name, piFLOW[®]p SMART uses machine learning to automatically tune the process, resulting in a flawless flow of materials. Smart enough to configure itself and quickly adjust settings, taking into account environmental conditions such as temperature and humidity, it beats even the most experienced operator every time!

Batch optimization

The combination of smart software, sensor technology and the Air Carrying Unit enables the entire filling volume of containers to be utilized and material throughput to be optimized. Correct tuning of the discharge time and/or readjustments due to environmental factors, such as humidity and temperature, are no longer dependent on the skills and experience of operators. This enables processors to always make the most of their batches, small or large.

Smooth processes

The continuous auto-tuning allows processes to run as smoothly as possible. In combination with the faster changeover, this saves time and money. The smart, self-optimising conveyor will always operate at the correct speed to perfectly suit specific applications.

Promoting productivity

Additional features, such as the ability to store material settings, offer further performance and productivity enhancement. By guaranteeing a flawless flow in every conveying cycle, regardless of the performance of the material or changes in the surrounding environment, piFLOW[®]p SMART is the perfect productivity promoter.



“After just a few cycles, piFLOW[®]p SMART has figured out what type of material it is dealing with and will automatically adjust itself to optimize how the material is conveyed.”

Milan Bratt
Product Manager Vacuum Conveying Division

Easy to learn and use

Operated through a user-friendly touch screen, piFLOW[®]p SMART is easy to learn to use and operate. Installation is straight forward, and built-in features, such as the anti-blockage function and air-assisted sensor cleaning, result in a system that requires only a minimal amount of maintenance.

Six times faster

● piFLOW@p SMART vs ● conventional vacuum conveyor

Optimal flow

Material flow

Time

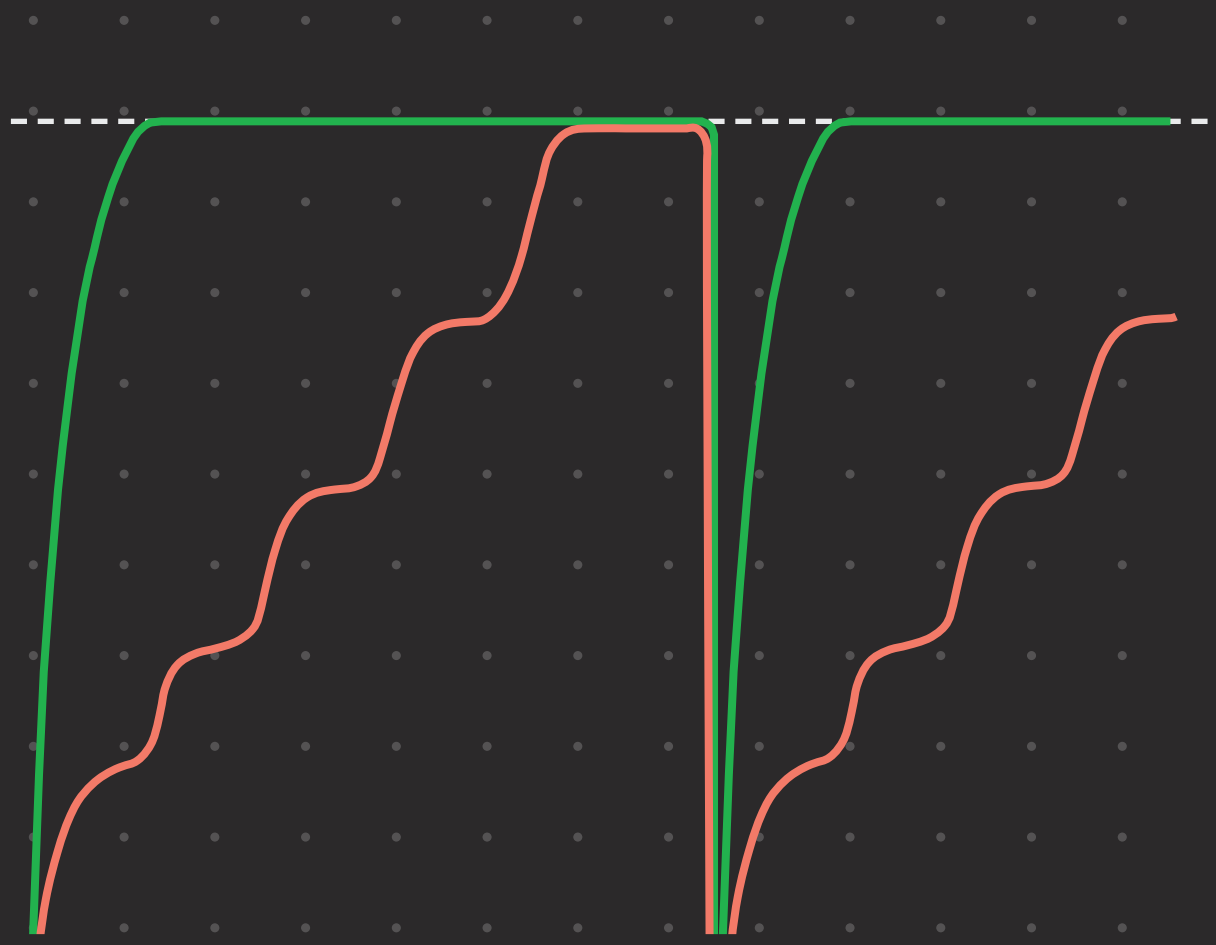

piFLOW®p

For your efficient filling processes

This conveyor is for when a premium technology is needed, e.g. in the food and pharmaceutical industry. It also makes sense when there is a big demand for high throughput performance with a small foot print. All conveyors are available with either an ejector driven vacuum pump or with a mechanical pump.

piFLOW®p conveyors are made of electropolished stainless steel and materials that comply with US FDA and EU 1935/2004 regulations. As a conveying line, a suction hose made of PU is used. An internal steel spiral helps to minimize the electrostatic charge of the product or diverts it to equipotential bonding. The filter in the upper part of the conveyor is cleaned with a filter shock after each conveying cycle. The device control is located in a separate control cabinet.

The modular design of the piFLOW®p vacuum conveyors enables you to remain highly flexible concerning future changes in the fast-moving markets. Piab's systems can just as easily be retrofitted and expanded or supplemented with additional modules to be prepared for new requirements.



Lower noise level



Simple maintenance



Smooth installation and easy to use

Certifications



- In compliance with FDA, EC No. 1935/2004 and EU No. 10/2011
- ATEX Dust and Gas certified
- Steel quality ASTM 316L (stainless steel, acid resistant), mechanically polished
- Designed according to USDA guidelines
- Hygienic design making maintenance and cleaning simple
- High throughput with a small footprint
- Wide capacity range from 2 to 56 liters per conveying cycle (up to 15 tons per hour [30,000 lbs/h])

Features overview

Material	Temperature	Weight ²	Feed pressure		
			Max.	Range ¹	Control range
ASTM 316L, EPDM, Q, NBR, ePTFE, PTFE, PE, PET, PA, Al, SS, PP	0 - 60 °C 32 - 140 F	10 - 103 kg 22 -227 lbs	0.7 MPa 102 psi	0.4 - 0.6 MPa 58 - 87 psi	0.4 - 0.6 MPa 58 - 87 psi

Air consumption	Vacuum	Noise level	Filter area	Particle size	Batch volume
2.5 - 112 NI/s 5.30 - 237 scfm	60 - 75 -kPa 18-22.2 -inHg	69 - 77 dBA	0.031 - 7 m ² 0.3 - 75 ft ²	min. 0.5 µm	2 - 56 l 0.07 - 1.98 ft ³

¹ Our recommended range of feed pressure.

With the quick-release system with filters and gaskets, the entire conveyor can be disassembled, cleaned and reassembled in just a few steps. Moreover, the conveyor can be cleaned not only in the shortest possible time, but also thoroughly so that no residues of the previous production contaminate the next.

Wet in place

The wet in place (WIP) function enables you to better meet even the most stringent health and safety standards. In addition to offering this function in new units, existing units can also be retrofitted with WIP nozzles.

The water sprayed by the WIP nozzles will wet any dust from any materials left in conveyors, stopping it from escaping into the air where it can be inhaled by processing staff during maintenance or cleaning procedures. By wetting potentially harmful leftover material before the equipment is opened for cleaning, the spray nozzles ensure that any such dust stays wet in place until it can be safely removed.

For maximum performance and coverage, and to make sure as much material as possible is captured as quickly as possible, up to three WIP modules can be fitted to each conveyor.

To achieve the optimal WIP performance for specific applications, two optional WIP module positions are offered in addition to the standard position at the top of the conveyor. One immediately below the middle section of the conveyor, and one below the bottom valve of the conveyor. Optional inlet valves can also be fitted at each side.



Do you want to know more?

Take a look at the online product page: www.piab.com

“The simple and uncomplicated cleaning of the Piab vacuum conveyors was the decisive factor in our decision”

Merlin Wintersteiger
Managing Director of Kora Füll GmbH



Automate the transfer of fragile materials

Piab's premium conveyors are designed with a stainless steel body (ASTM 316L), meet the very high hygienic demands of FDA and are ATEX Dust certified as well as ATEX Gas certified. Typical applications are transfer of tablets, capsules, coffee, granules and other fragile products. Also hygienic applications or places where space is at a premium.

When a premium technology is needed for transporting fragile tablets, capsules, coffee, granules and other fragile products in the pharmaceutical, food and nutraceutical industries. It also suits when there is a big demand on high throughput performance with a small foot print.

piFLOW®t will together with piGENTLE® automatically convey tablets or capsules without breaking or chipping thanks to a controlled flow and constant speed, guided entry and the elimination of all sharp edges. Those are the keys to our success, ensuring that fragile products are handled with great care in our conveyor.

The conveyor is fully configurable in all its parts, which allows it to be adapted to suit any application, individual products, and any



Controlled flow



Less waste



Simple maintenance



Easy to integrate

Certifications



production line. It can be used either as a stand-alone conveyor or as a pre-separator with a remote motor.

Return on investment will be affected positively thanks to both the automation of a normally manual process and through a decreased amount of waste due to chipped products.

- In compliance with FDA, EC No. 1935/2004 and EU No. 10/2011
- ATEX Dust and Gas certified
- Steel quality ASTM 316L (stainless steel, acid resistant)
- Designed according to USDA guidelines
- Hygienic design making maintenance and cleaning simple

Features overview

Material	Temperature	Weight	Feed pressure		
			Max.	Range ¹	Control range
ASTM 316L, EPDM, Q, NBR, ePTFE, PTFE, PE, PET, PA, Al, SS, PP	0 - 60 °C 32 - 140 F	20 - 50 kg 44 - 110 lbs	0.6 MPa 87 psi	0.2 - 0.6 MPa 29 - 87 psi	0.4 - 0.6 MPa 58 - 87 psi
Air consumption	Vacuum	Noise level	Filter area	Particle size	Batch volume
6 - 28 NI/s 12.7 - 59.3 scfm	0 - 75 -kPa 0 - 22.2 -inHg	69 - 77 dBA	0.09 - 0.25 m ² 1 - 2.7 sq ft	min. 0.5 µm	10 l 0.35 ft ³

¹ Our recommended range of feed pressure.

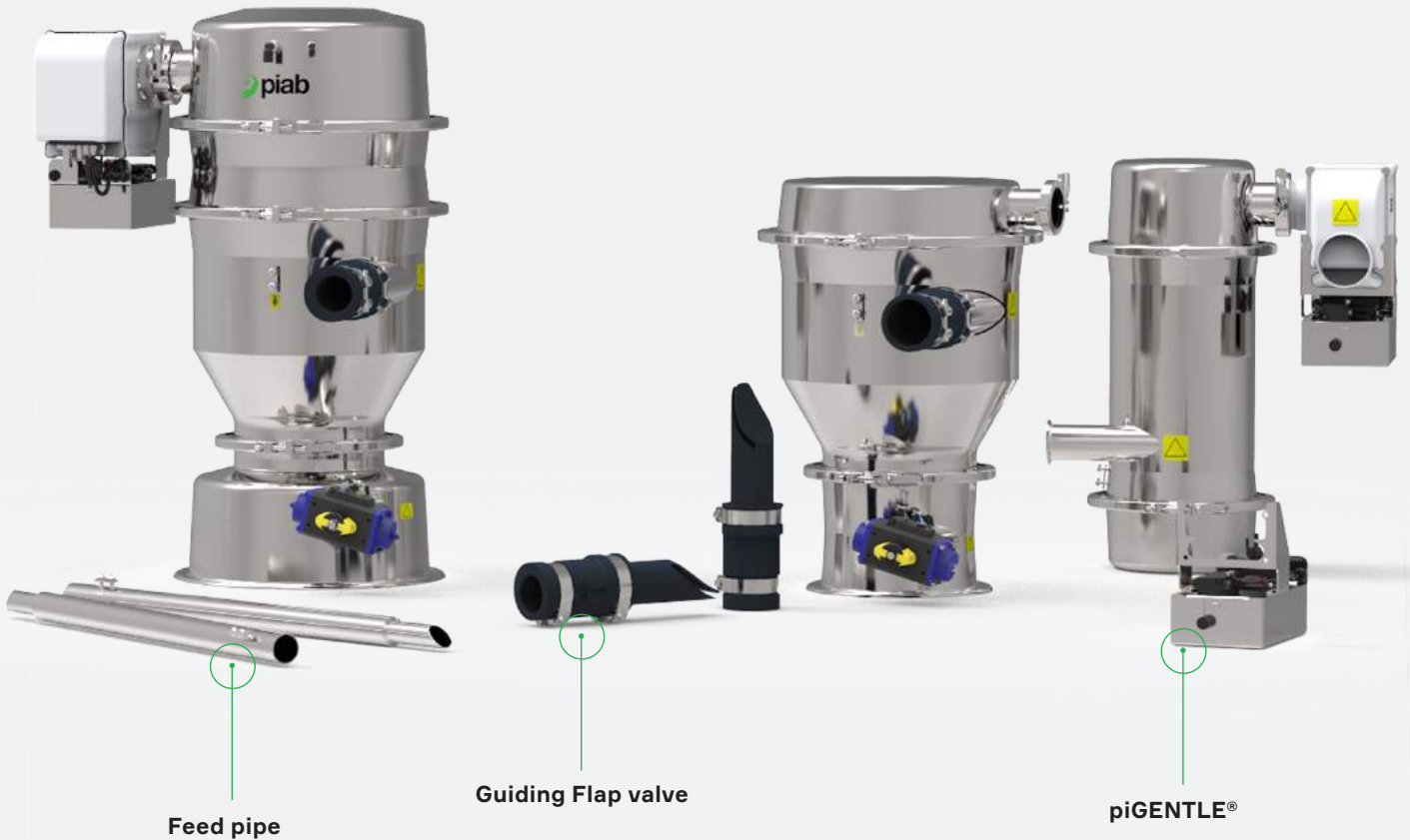

Eliminating the use of inadequate standard equipment and alternative, often back-breaking, manual procedures, piFLOW[®]t will safely transfer ingredients and products between the various processing units, such as tablet presses, coating drums, and packaging lines, avoiding all risks of damage.

Safe entry into the conveyor

A guiding flap valve is used to facilitate a tangential entry into the inlet module. This will enable a smooth transition between the conveyor and pipeline

piFLOW[®]t conveyors can be used to transport any fragile materials within a processing plant.

piGENTLE[®]

At the core of piFLOW[®]t is the proprietary piGENTLE[®], a patented technology that maintains a gentle tablet flow by regulating the

feed pressure of the vacuum pump, ensuring that tablets, capsules or other fragile products are handled as delicately as possible.

piGENTLE[®] regulates the feed pressure of the pump by sensing the vacuum level in the system. As it has a low start pressure, it will enable tablets to be picked up at a low speed. When the tablets fill up the pipe line the vacuum level increases and consequently the feed pressure is increased. The feed pressure is regulated between 2 and 6 bar (29 and 87 psi).

- Perfect fit for transport of fragile materials
- Deduster function with pre-separator solution
- Smooth installation and easy to use
- High throughput with a small footprint

Hygienic and easy to clean

A modular system made up of few parts, the piFLOW[®]t is very easy to clean and to maintain. All parts can be disassembled without tools.

The vacuum conveyor that handles all

This conveyor is specialized for conveying powder and granules in food industries producing for example chocolates, cookies, chips, spices and coffee.

piFLOW[®]fc is designed to meet high requirements of food industry in terms of hygiene, safety and process accuracy, but not requiring the use of full acid-resistant stainless steel.

The conveyor features the same design as Piab's premium range piFLOW[®]p and piFLOW[®]t conveyors, but in electropolished stainless steel (ASTM 304) rather than the acid-resistant grade (ASTM 316L).

It offers a fully contained unit that enables toxic and allergenic powders to be transported without the risk of operators and the surrounding work environment being exposed to hazardous or sensitive materials.

 High throughput

 Less waste

 Simple maintenance

 Smooth installation and easy to use

Certifications



Available in a wide capacity range from 3 to 33 liter (0.1 ft³ to 1.2 ft³) per conveying cycle, up to 8 metric tons/h (17 000 lb/hr), it offers high throughput at a small footprint.

- In compliance with FDA, EC No. 1935/2004 and EU No. 10/2011
- Steel quality ASTM 304 (stainless steel)
- Hygienic design making maintenance and cleaning simple
- High throughput with a small footprint
- Antistatic filter and seals are available

Features overview

Material	Temperature	Weight	Feed pressure		
			Max.	Range ¹	Control range
ASTM 304, ASTM 316L, NBR, ePTFE, PET, PA, AI, SS, PP	0 - 60 °C 32 - 140 F	19 - 55 kg 42 - 121 lbs	0.7 MPa 102 psi	0.4 - 0.6 MPa 58 - 87 psi	0.4 - 0.6 MPa 58 - 87 psi
Air consumption	Vacuum	Noise level	Filter area	Particle size	Batch volume
5 - 56 NI/s 10.6 - 119 scfm	60 - 75 -kPa 18-22.2 -inHg	62 - 75 dBA	0.06 - 1.5 m ² 0.65 - 16 ft ²	min. 0.5 µm	3 - 33 l 0.10 - 1.17 ft ³

¹ Our recommended range of feed pressure.

piFLOW[®]fc comes with a selection of various accessories: from several filter types to feeding stations and feed adaptors. All filters are designed with a standardized interface, meaning different filter types can be used in the same conveyor, all depending what material that is conveyed at different times.

COAX[®] technology, used throughout the piFLOW[®] conveyor range, ensures that vacuum is created in the most energy efficient and cost-effective way possible, and is only used when the pump is running. Automatic filter cleaning and an overall hygienic design make the piFLOW[®]fc easy to clean, requiring minimal maintenance.

Chocolates, cookies,
crisps and coffee but
also certain chemicals
– the piFLOW[®]fc vacuum
conveyor handles all.





With the growing demand of greater production volumes Piab offers now the piFLOW®f for larger batch volumes. The new piFLOW®f has a 28L housing and offers possibilities to increase the pump performance. This is done by installing two piBASIC 400 or 600 pumps.

With our broad experience in conveying different products, no extra test runs are needed. This allows to deliver the system needed in the shortest possible time.

This increases the capacity of the conveyor from the current 5 tons per hour (14L content and piBASIC600 pump) the now small conveyor to 7.5 tons per hour (28L content and 2x piBASIC600 pumps).

This is same as from increasing the current 11 000 lb (0.5 ft³ content and piBASIC600 pump) the now small conveyor, to 16 500 lb (1 ft³ and 2 piBASIC600 pumps).

The Piab conveyors for the food industry are equipped with a housing made of stainless steel (ASTM 304) and the seals, which are in direct contact with the product to be conveyed, meet both the FDA and all European guidelines to meet the requirements of the food industry . Piab's piFLOW®f is also ATEX Dust certified.



Automate your process with ease

This is a conveyor widely used in the industry where food grade quality is a demand. It has a high throughput performance as well as a small foot print. This conveyor is often used as an alternative to mechanical conveyors.

An entry-level vacuum conveyor designed for industries where food grade quality, a dust free environment and easy maintenance are required.

piFLOW®f is a vacuum conveyor specialized in the conveying of food. It offers the optimal solution when deciding to change from manual to an automated process. piFLOW®f helps to relieve employees, to increase a careful use of resources and ensures that the production process runs more efficiently, generating greater reliability.

The conveyor can be integrated into an existing system or can be designed for a completely new line. For more flexibility within the plant the conveyor can be placed on a mobile frame to be used at different stations on the production line.



Energy efficient



Less waste



Simple maintenance



Ergonomic process

Certificat



Another advantage is that the pump is based on COAX® technology, the most energy efficient way to create a vacuum and convey the products in a gentle way without any damage.

- In compliance with FDA, EC No. 1935/2004 and EU No. 10/2011
- ATEX Dust certified
- Steel quality ASTM 304 (stainless steel)
- High throughput with a small footprint

Features overview

Material	Temperature	Weight	Feed pressure		
			Max.	Range ¹	Control range
ASTM 304, EPDM, NBR, ePTFE, PTFE, PE, PET, PA, Al, SS	0 - 60 °C 32 - 140 F	27 - 42 kg 60 - 93 lbs	0.7 MPa 102 psi	0.4 - 0.6 MPa 58 - 87 psi	0.4 - 0.6 MPa 58 - 87 psi
Air consumption	Vacuum	Noise level	Filter area	Particle size	Batch volume
5 - 74 NI/s 10.6 - 157 scfm	60 - 75 -kPa 18-22.2 -inHg	69 - 77 dBA	0.09 - 0.5 m ² 1 - 5.4 ft ²	min. 0.5 µm	6, 8, 14, 28 l 0.21, 0.28, 0.49, 0.99 ft ³

¹ Our recommended range of feed pressure.

Safe transfer of hazardous materials

This is a conveyor widely used in the general industry and sometimes in the chemical industry. It has a high throughput performance as well as a small foot print. This conveyor is often used as an alternative to mechanical conveyors when there is a requirement for dust free conveying or low maintenance.

A cost-effective solution for any industry, that wishes to automate the manual material handling process for improved throughput.

piFLOW®i offers a fully contained unit that enables toxic and allergenic powders to be transported without the risk of operators and the surrounding work environment being exposed to hazardous or sensitive materials.

This conveyor is designed with a full opening option making it possible to maximize the material throughput and increase the overall capacity of the system. The full opening gives an instant discharge.



Simple maintenance



Smooth installation and easy to use



Cost-effective solution

Certifications



- ATEX Dust certified
- Steel quality ASTM 304 (stainless steel)
- High throughput with a small footprint
- For general industry applications with a need to handle abrasive powders

Available in a capacity range from 6 to 28 liter (0.2 ft³ to 1.0 ft³) per conveying cycle, up to 7.5 tons/h (16 500 lb/h), it offers high throughput at a small footprint.

Designed to meet the needs without compromising between price, technical performance and energy consumption.

Features overview

Material	Temperature	Weight	Feed pressure		
			Max.	Range ¹	Control range
ASTM 304, EPDM, NBR, ePTFE, PTFE, PE, PET, PA, Al	0 - 60 °C 32 - 140 F	27 - 42 kg 60 - 93 lbs	0.7 MPa 102 psi	0.4 - 0.6 MPa 58 - 87 psi	0.4 - 0.6 MPa 58 - 87 psi
Air consumption	Vacuum	Noise level	Filter area	Particle size	Batch volume
5 - 74 NI/s 10.6 - 157 scfm	60 - 75 -kPa 18-22.2 -inHg	69 - 77 dBA	0.09 - 0.5 m ² 1 - 5.4 ft ²	min. 0.5 µm	6, 8, 14, 28 l 0.21, 0.28, 0.49, 0.99 ft ³

¹ Our recommended range of feed pressure.

piFLOW®i comes with a selection of various accessories: from several filter types to feeding stations and feed adaptors. All filters are designed with a standardized interface, meaning different filter types can be used in the same conveyor, all depending what material that is conveyed at different times.

With the growing demand of greater production volumes Piab offers now the piFLOW®i for larger batch volumes. The new piFLOW®i has a 28L (1.0 ft³) housing and offers possibilities to increase the pump performance. This is done by installing two piBASIC 400 or 600 pumps.

This increases the capacity of the conveyor from the current 5 tons per hour (11,000 lb per hour) with 14L (0.5 ft³) content and piBASIC600 pump for the now small conveyor to 7.5 tons per hour (28L or 1.0 ft³ content content and 2x piBASIC600 pumps).

COAX® technology, used throughout the piFLOW® conveyor range, ensures that vacuum is created in the most energy efficient and cost-effective way possible, and is only used when the pump is running. Automatic filter cleaning and an overall hygienic design make piFLOW®i easy to clean, requiring minimal maintenance.



Piab's vacuum conveying systems are built of high quality material. In the food, pharmaceuticals, chemical and additive manufacturing industries there are demands on highest possible degree of operational safety and hygiene. Piab's piFLOW® conveyors have been developed as an answer to those strict requirements.

Industries

Food and Beverage



The food and beverage industry focuses on hygienic and safe production meeting the strict requirements of the FDA, EU, ATEX and other requirements with no compromise on health, safety, or product quality. Piab's innovative products and solutions are modular in design and secure the highest quality of finished goods.

Baking goods

Convey various forms of flour, sugars, starches, seasoning, nuts and change materials quickly and effectively. Piab vacuum conveyors are easy-to-clean, versatile and allow quick changeover which make them the perfect choice in the baking goods industry.

Coffee

Handling operations within the coffee industry is a delicate task. From large-scale industrial roasteries to small-scale micro roasteries, the goal is the same: to deliver a high-quality product to end consumers. Piab's vacuum conveyors are customizable to your operation and don't affect the characteristics of your product.

Confectionery and candy

Either it's sticky, hygroscopic sugar in various forms, cocoa powder or flour; or finished, fragile candy products, Piab offers the optimal conveying solution. To ensure quick changeover Piab's SMART technology can automatically change settings to optimize your production.

Instant food

Instant food such as dry soups, noodles or spices can be easily conveyed with Piab vacuum conveyors. Conveyed materials are dusty or have a high fat content, so it's crucial to use equipment which is easy to clean and allows for a fast changeover between products. Dense phase conveying can be applied to minimize segregation, and the enclosed system helps to increase productivity as well as ensure employee health and safety.



Nutraceuticals

Health claims are hard to acquire - requirements towards the production of nutraceuticals can be as high as in the pharmaceuticals industry with similar challenges such as cross-contamination and dust generation. Piab provides the appropriate conveying solution for the applicable requirements

Applications

- Feeding materials to and from mixer/blender/sieving unit/dosing unit/tablet press/capsule filling machine and more.
- Feeding packaging machines/portioning machines
- Reclaim products

Best conveyors to choose from



piFLOW®p SMART



piFLOW®p



piFLOW®fc

Why choose Piab vacuum conveyors

- **Ergonomic:** eliminates manual handling of bags from the process
- **Hygienic and safe:** made for direct contact with products
- **Ensures human safety:** enclosed system to reduce exposure to dust
- **Easy to use:** quick changeover of materials, easy cleaning
- **Optimized:** tailor-made for any application, low production down time
- **Compliant:** built to meet industry requirements
- **Profitable:** reduces waste
- **Gentle:** doesn't damage the conveyed materials
- **Small footprint:** requires less floor area compared to mechanical conveyors.



Do you want to know more?

Take a look at the online product page: www.piab.com/industries/food-beverage

Pharmaceuticals



The pharmaceutical industry requires the highest safety, hygienic, and quality equipment to meet industry standards and strict regulations. Our products exceed these requirements allowing for optimized productivity at no cost to human safety.

Powder, tablets and capsules

In the production of pharmaceuticals, powder, tablets and capsules are transported either through manual handling or an automated solution. Challenges to address are many such as health and safety of the staff, contamination, material segregation, product waste, as well as compliance and quality. Our solutions are customized to your needs, enabling a safe and enclosed system between the process steps. Piab offers intelligently designed solutions that efficiently connects the flow from start to finish.

Piab offers a variety of customized solutions for your specific needs, such as transition pieces for tablet presses from main manufacturers or special equipment for your application.



Applications

- Feeding material to and from mixer/blender/sieving unit etc.
- Feeding tablet press/capsule filling machine
- Feeding packaging machines
- Reclaiming products
- Conveying to and from metal detection equipment

Why choose Piab vacuum conveyors

- Ergonomic: eliminates manual handling from the process
- Ensures human safety: enclosed system to reduce exposure to dust
- Compliant: built to meet industry requirements
- Profitable: reduces waste
- Gentle: doesn't damage the conveyed materials
- Small footprint: takes little space
- Efficient: made to quickly transfer powders without material segregation
- Human focus: easy to maintain, hygienic, and safe

Best conveyors to choose from



piFLOW®p SMART



piFLOW®p



piFLOW®t



Do you want to know more?

Take a look at the online product page: www.piab.com/industries/pharmaceuticals

Chemical



Minimize dust exposure, save floor space, and reduce scrap with our solutions for the chemical industry. We provide high quality technology created to ensure human safety and increase productivity. Maintenance, regular cleaning, and filter changes are easily done to minimize your production down time.

Desiccants

Desiccants are used in the food, pharmaceuticals, consumer goods, and electronics markets to absorb moisture/water in order to keep products dry. Piab's enclosed vacuum conveying system helps to minimize dust generation and employee exposure during the production of desiccants.

Do you work with free-flowing chemicals or want to transfer small particles, such as plastic parts? We offer lab testing to support you in selecting the right conveyor.

Detergents

Capsulated enzymes, powders containing enzymes or other additives are transported with ease with Piab speed control which optimizes transfer speed without damaging the delicate enzymes. However, the enzyme dust is hazardous to human health so it's crucial to minimize exposure. Our enclosed vacuum conveying system outfitted with state-of-the-art ULPA filters ensures the safety of employees and air cleanliness.

Toners, water treatment, paints and more

Toner, carbon powder, gypsum, diatomaceous earth, soda ash, citric acid, titanium dioxide, iron oxide, plastic granules and powders are examples of materials that can be handled by Piab vacuum conveyors. Get your material tested by our application engineers to find the best solution for your needs!



Applications

- Feeding material to and from mixer/blender/reactor/dosing machine
- Feeding tablet press
- Feeding packaging machines
- Reclaim products

Why choose Piab vacuum conveyors

- Ergonomic: eliminates manual handling from the process
- Expert advice: optimal conveying solution from application engineers
- Safe: convey hazardous materials without taking risks
- Profitable: reduces waste
- Optimized: low production down time
- Small footprint: takes little space
- Human focus: easy to maintain, hygienic, and safe

Best conveyors to choose from



piFLOW®p



piFLOW®fc



piFLOW®i



Do you want to know more?

Take a look at the online product page: www.piab.com/industries/chemical

Additive Manufacturing

Our innovative vacuum conveying technology is well suited to solve challenges related to additive manufacturing such as safe handling of hazardous materials or easy transfer of materials to and from the 3D printer.

Piab's vacuum conveyors are ideal for filling a printer with metal powders, reclaiming or cleaning excess material from the printers' post-production, and filling or emptying metal powders from and to adjacent equipment such as a sieve or a powder container. Our vacuum conveyors can handle high density materials and transfer them with speed and reliability.

Furthermore, Piab has vacuum conveying solutions for non-inert and inert atmospheres, and tests prove we can convey powder with a bulk density of 8 kg/liter [500 lbs/ft³] giving a throughput of 200 kg/h [450 lbs/h]. We provide a solution for conveying powders to Powder Bed Fusion, Binder Jetting machines and more.

The use of Piab's vacuum conveying technology will protect the operator from

contact with hazardous materials, the metal powder from contamination, unwanted chemical reactions and the environment from pollution in the additive manufacturing process.

The piFLOW® vacuum conveyors were developed as closed systems to solve these challenges. Filters in the vacuum conveyor as well as additional exhaust air filters on the vacuum pump prevent fine dust from entering the workspace and thus avoiding employees to be exposed to hazardous substances.

piFLOW® vacuum conveyors are also ATEX certified and come with a 5-year warranty.

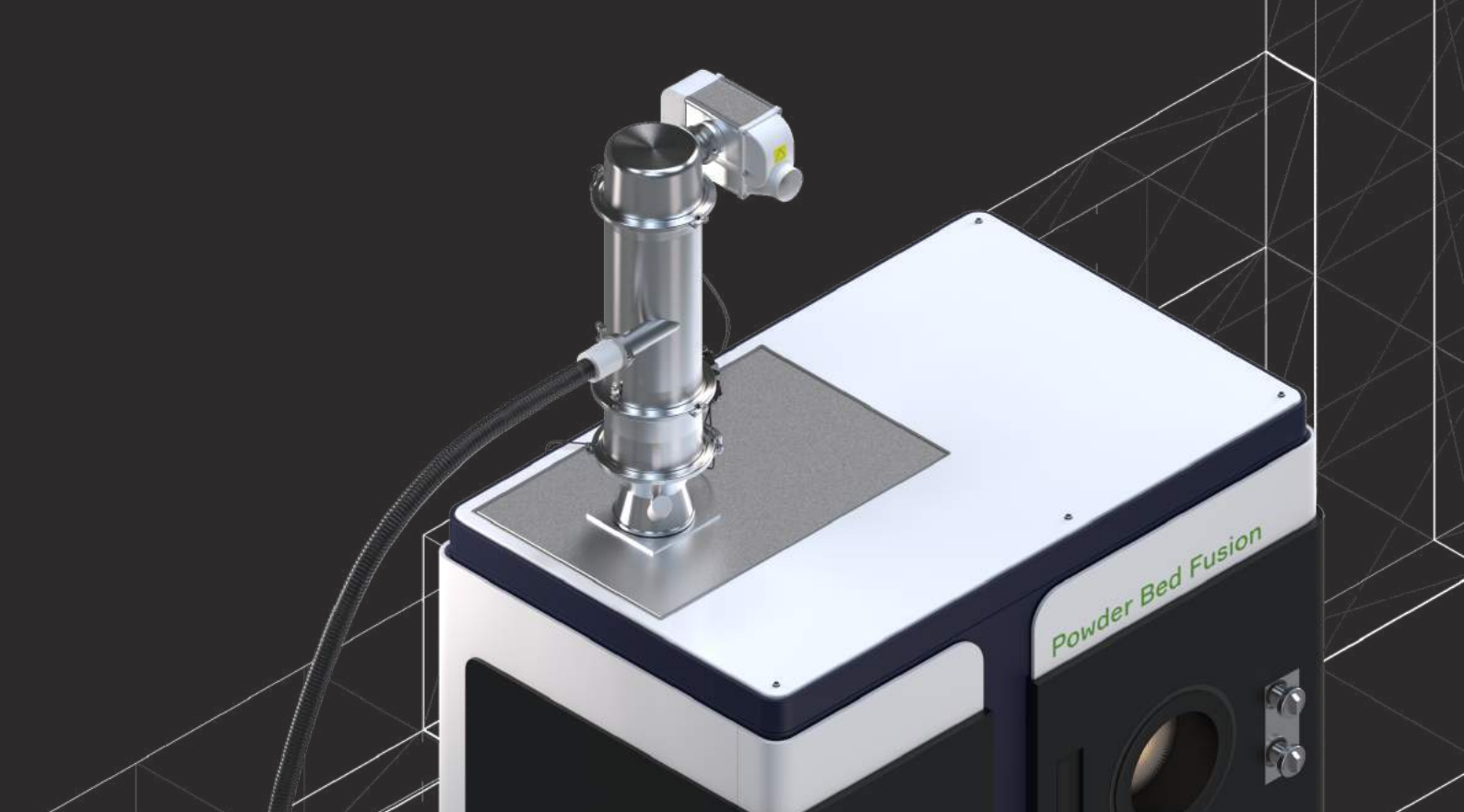

Applications

- Feeding metal powder to printer, sieve or hopper
- Reclaim metal powder from printer



Best conveyor to choose



piFLOW®p



Do you want to know more?

Take a look at the online product page: www.piab.com/industries/additive-manufacturing

Why choose Piab vacuum conveyors



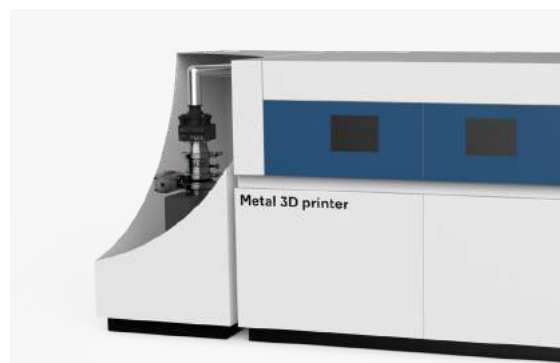









- Innovative: continually developing top of the line conveyors
- Productive and efficient: quick conveying without risk of external contamination
- Optimized with few moving parts: low maintenance, maximal up time
- Traceable: monitor the material flow
- Ergonomic: eliminates manual handling from the process
- Safe and hygienic: convey hazardous metal powders without taking risks
- Profitable: reduces waste
- Small footprint: takes little space
- Flexible and highly configurable



The vacuum conveyor is reliable and requires minimum maintenance. It is, however, necessary to regularly change some of the parts to maintain maximum productivity. To optimize your conveyor, Piab offers a wide range of different accessories.

Accessories and Spare parts



Number	Feed points	Compatibility	Material	Certifications
1	Suction pipes	piFLOW [®] i/f	pickled ASTM304	 
2	Feed nozzles	piFLOW [®] p/t	electropolished ASTM316L	 
3	Bag dump station	piFLOW [®] i/f	pickled ASTM304	 
4	Feed adapter for food and chemicals	piFLOW [®] i/f	pickled ASTM304	 
5	Feed station	piFLOW [®] p/t	ASTM316L, ASTM304	 
6	Feed adapter for food, pharma and chemicals	piFLOW [®] p/t	electropolished ASTM316L	 



**Do you
want to know more?**

Find the full range of feed points and other accessories
here: www.piab.com/industries/additive-manufacturing

Accessories and Spare parts

The vacuum conveyor represents usually just one part of a larger production plant. Therefore, it is very important that all the individual parts of the system are working together perfectly.

Piab's accessories and spare parts are designed to perfectly complement our vacuum conveyors so that your production line is fully equipped with high quality products, maximizing your overall productivity.

For every production line, for different characteristics of the product, and for various environmental conditions Piab offers the right conveyor with suitable accessories.



Electric controls

The electrical control unit controls the functions of the conveyor and is based on software developed by Piab, making different settings more visual through the user-friendly HMI (Human Machine Interface).



Other accessories:

There are several other accessories, such as second stage filter units, vacuum filters, mounting girdles etc. to further optimize your conveyor.



Pneumatic controls

Piab's control units are fully pneumatic, operated with an extremely reliable function. The full pneumatic design also removes any source of ignition from the system and at the same time simplifies the validation process.

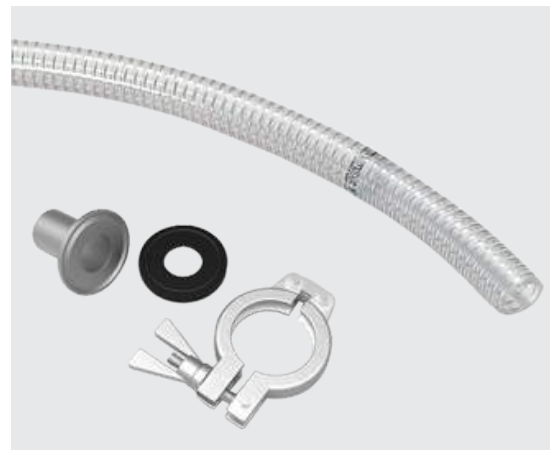

Piping

To complete the conveying system Piab offers stainless steel pipe bends, food grade hoses, different types of pipe fittings, pipeline emptying units, pinch valves and many other solutions.

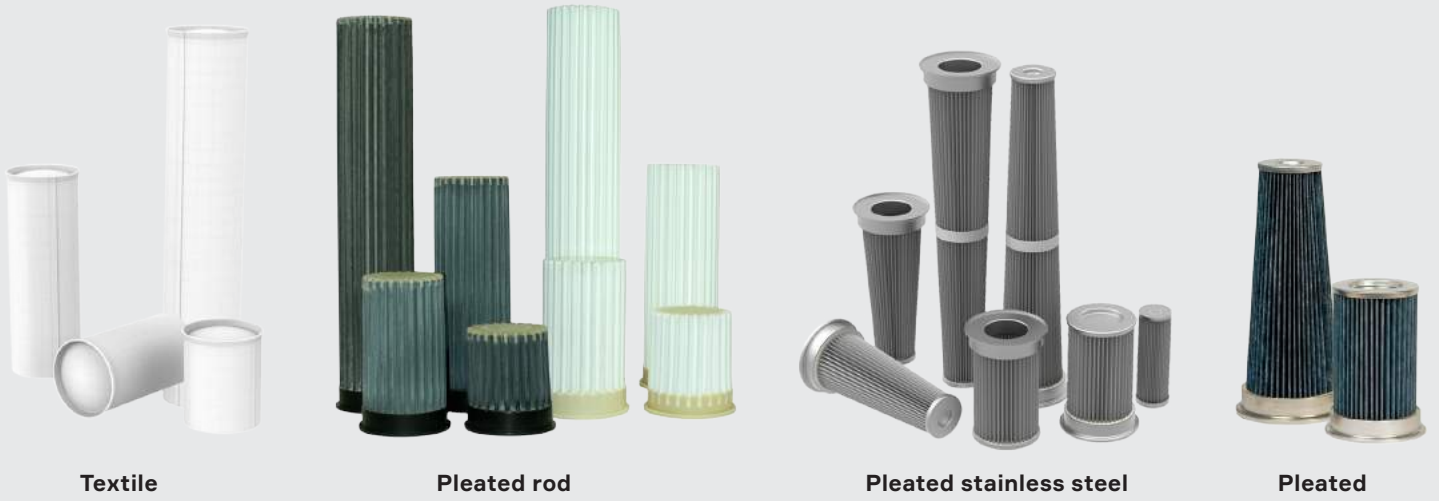

Textile

Pleated rod

Pleated stainless steel

Pleated

Filters

Filters are used to filter dust and other small particles from the vacuum flow. It reduces the risk of operation, breakdown or stoppage in the pump. There is a selection ATEX approved filters and a selection of stainless steel filters for sterilization when cleaning.

Vacuum pumps/ Generators

To optimize, upgrade or complete a conveyor, Piab also offers the vacuum pumps/ generators as stand-alone units.



Conveyor body

Modular parts for the conveyor to increase batch volume or protect the filter.

Evolving around the world

EUROPE

France

Lagny sur Marne
+33 (0)16-430 82 67
info-france@piab.com

Germany

Butzbach
+49 (0)6033 7960 0
info-germany@piab.com

Italy

Torino
+39 (0)11-226 36 66
info-italy@piab.com

Poland

Gdansk
+48 58 785 08 50
info-poland@piab.com

Spain

Barcelona
+34 (0)93-633 38 76
info-spain@piab.com

Sweden

Täby (HQ)
+46 (0)8-630 25 00
info-sweden@piab.com

Kungsbacka
Lifting Automation
+46 (0)300-185 00
eh.info@piab.com

United Kingdom

Loughborough
+44 (0)15-098 570 10
info-uk@piab.com

AMERICAS

Brazil

Sao Paulo
+55 (0)11-449 290 50
info-brasil@piab.com

Canada

Toronto (ON)
Lifting Automation
+1 (0)905-881 16 33
eh.ca.info@piab.com

Hingham (MA, US)

+1 800 321 7422
info-usa@piab.com

Mexico

Hingham MA (US)
+1 781 337 7309
info-mxca@piab.com

USA

Hingham (MA)
+1 800 321 7422
info-usa@piab.com

Xenia (OH)
Robotic Gripping
+1 888 727 3628
info-usa@piab.com

ASIA

China

Shanghai
+86 21 5237 6545
info-china@piab.com

India

Pune
+91 8939 15 11 69
info-india@piab.com

Japan

Tokyo
+81 3 6662 8118
info-japan@piab.com

Singapore

Singapore
+65 6455 7006
info-singapore@piab.com