

Robotic gripping

Vacuum handling solutions



JOULIN
vacuum handling



KENOS

Vacuum Handling

Handling Solutions for all Your Products

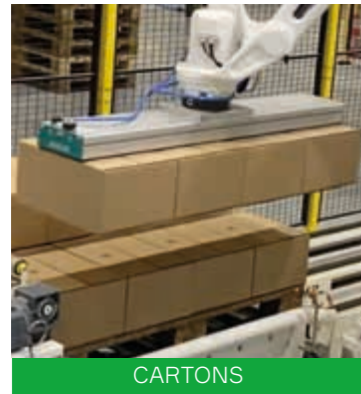

CARTONS



BRICKS



CANS



GLASS JARS

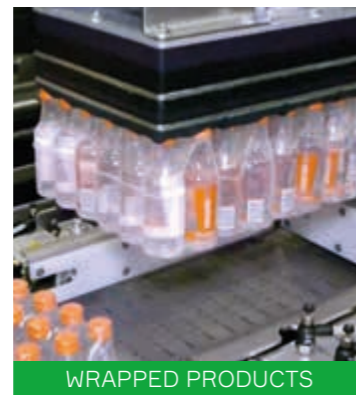

WRAPPED PRODUCTS



TINS

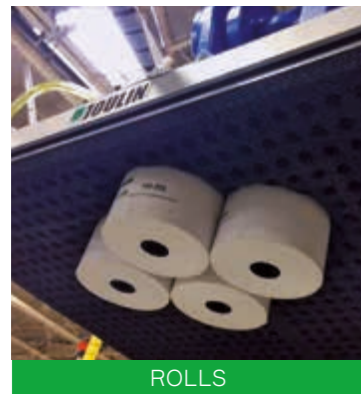

ROLLS

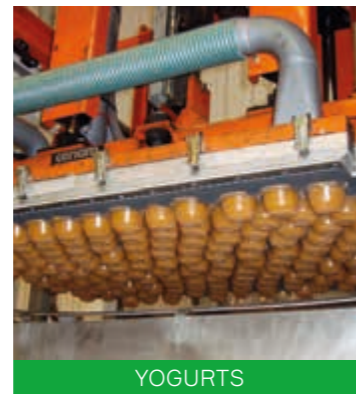

YOGURTS

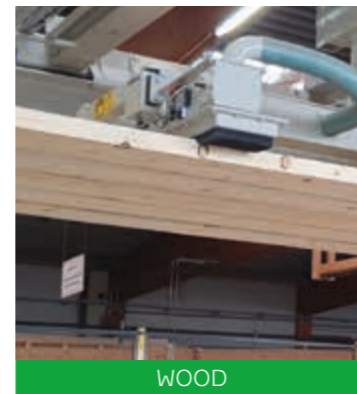

WOOD



BAGS



AEROSOLS

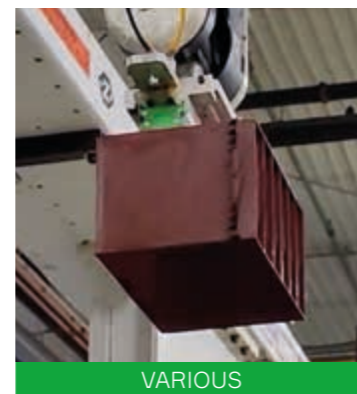

VARIOUS

#1 Robotic Gripping solutions in the world

At **Piab** we evolve automation, creating **sustainable solutions for a safer and more efficient workplace in an automated world.**

We provide gripping skills to robots for all industries, whether you are picking **complete layers, partial layers, single parts or mixed parts**, and no matter if you handle cartons, cans, wrapped products, wood, bricks, bags, plastic, etc., **our gripping technologies have it covered.**

Our offering spans **from configurable standards to fully customized gripping solutions** and our **Joulin, Kenos and Piab combined portfolios** can provide you with just **the right solution for your needs.**

With **engineering and production capabilities in multiple locations** around the world we have the possibility to serve you locally as well as globally.



Standard range

Technology

CHECK VALVES (VG/CV)

- Independent check-valves system

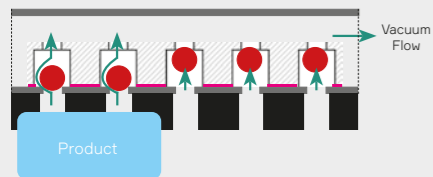

PISAVE SENSE (PI)

- Multiple port fittings

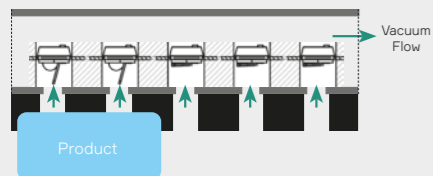

FLOW RESTRICTION (PG/FR)

- Calibrated orifice adjustments

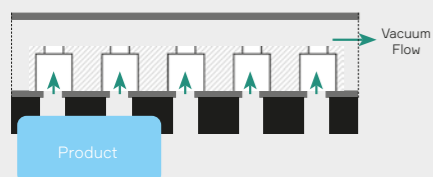

FOAM VALVES (FV/CJ)

- Diffused vacuum in the full surface of the products

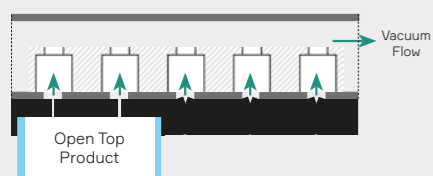

BAG GRIPPER (BG)

- Perimetrical seal

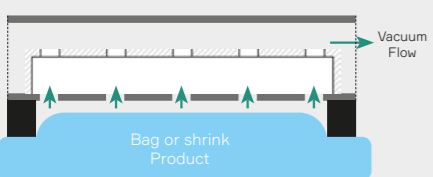

Pick & place / cobot solutions



KFG / FLEXIGRIP

With integrated or external vacuum generation, it will be the solution for your pick & place applications. Easily adjustable and evolutive.



PICOBOT

Designed for deployment with small industrial robots but also safe for collaborative applications.



KSL / SAFE & LIGHT

The COBOT gripper. Naturally adapted for collaborative application with the foam body. Safe&Light lift up to 20 times its weight.



KCS

The KCS gripper is equipped with integrated cartridges for handling different sized sealed or leaking objects with the same lifting device.

Aluminum extrusion

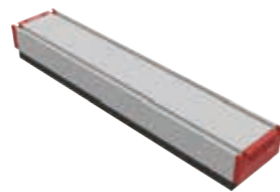

KVG-F

The KVG grippers can be equipped with integrated vacuum generation or suitable for separated vacuum generation.



KGV-C

The material of the KVG gripper (cups) is made of a specially developed material that features the elasticity of rubber and wear resistance of polyurethane - DURAFLEX®.



EGV

For unit handling by rows or by layers. Equipped with integrated cartridges.



EGB

For unit handling by rows or by layers. Used with flow reverser or Blower Control Module.

Product dedicated



KSG

The KSG is designed and capable to handle heavy sacks in different materials, shapes and weight.

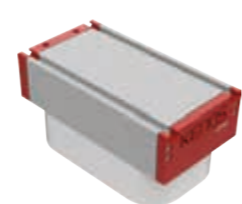

KBC

Especially dedicated to the handling of flow packs, food bags and small sacks; it is quite efficient for fast and safe liquid bags handling.



LUMBER GRIPPER

The ideal gripper for wood handling. Not sensitive to dust.



EHD

The new gripper for wood industry. Valve grippers with extended qualities thanks to heavy duty disk valves.

Palletizing

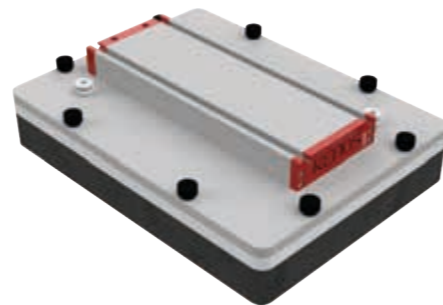

KVGL-S

This gripper allows for superior gripping on different types of boxes, wrap around packaging and primary ones.

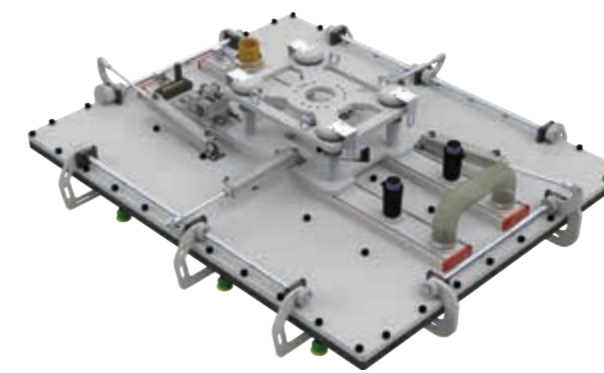

KVGL-CJ

This vacuum gripper handles cans and jars, typical industrial segments involved are palletizing or de-palletizing in packaging, beverage and food.

Vacuum generation



PIAB EJECTORS

The internal vacuum supply is generated by Venturi ejectors integrated on the gripper.

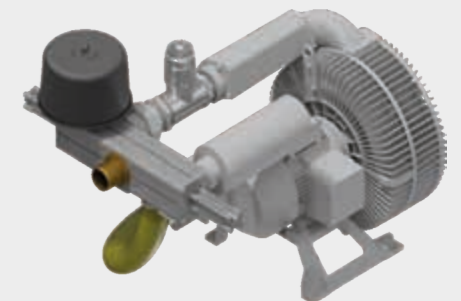

FLOW REVERSER

The flow reverser helps for a quick release of light products. It sends air or vacuum inside the the gripper.

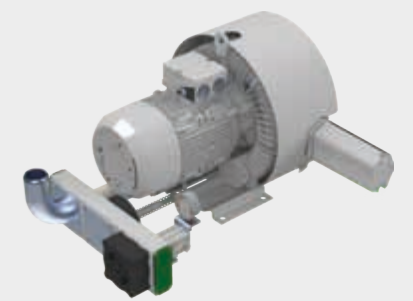

BLOWER CONTROL MODULE

Vacuum blower with standard module including beathing cylinder and safety vacuum valve.

Custom range

Benefits

We adapt
to your needs

- **Your dimensions**
Our grippers can be tailored to handle single or multiple objects through zoning of the grippers.
- **Your products**
Our grippers can handle majority of materials and objects as well as turn them horizontally and/or vertically during the picking of the objects.
- **Your operations**
Our grippers are designed to be durable and reliable as well as being easy to install and conduct maintenance on.

Custom specialists

We have thousands of successful applications in all the industries : wood, food, cosmetic, pharmaceutical, logistics and many more industries.

Our organization based on project engineers and sales managers guarantees a real consulting capacity, as well as the design and delivery of the most suitable solution within a nominal timeframe.

Versatile and rugged
According to your needs / dimensions

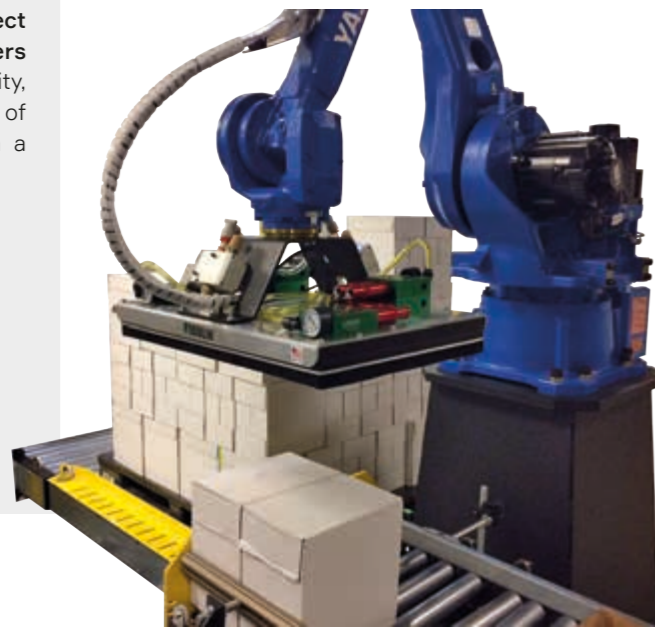
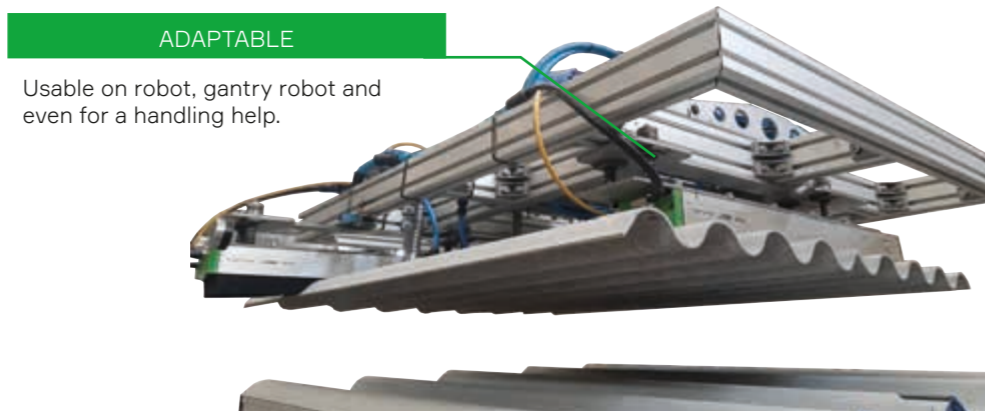
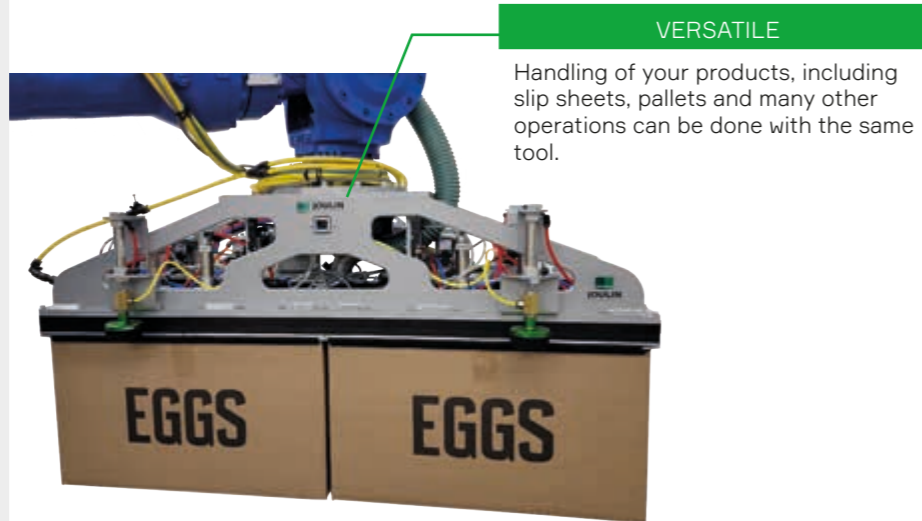

RUGGED
Designed to work in unfriendly, challenging environments.

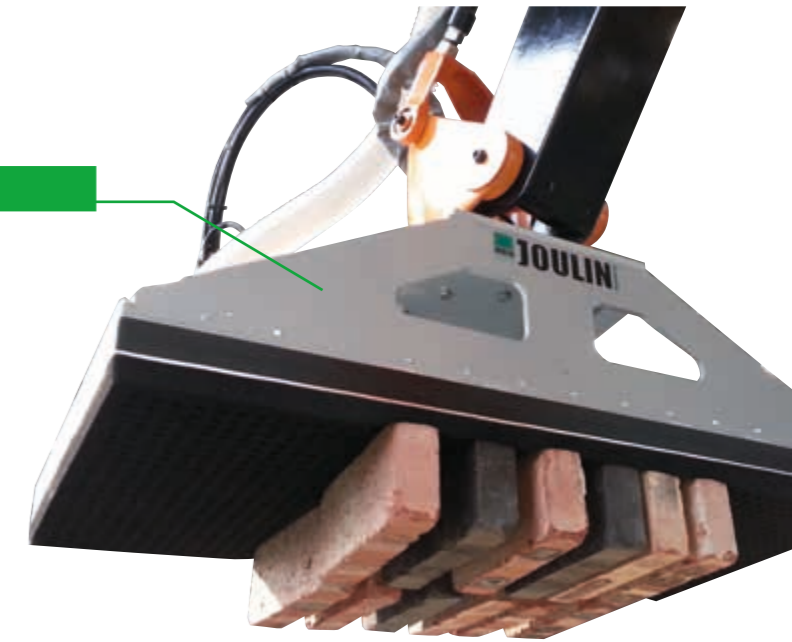

YOUR DIMENSIONS
Round, square, rectangular or other - we customize the tool to your desired size.

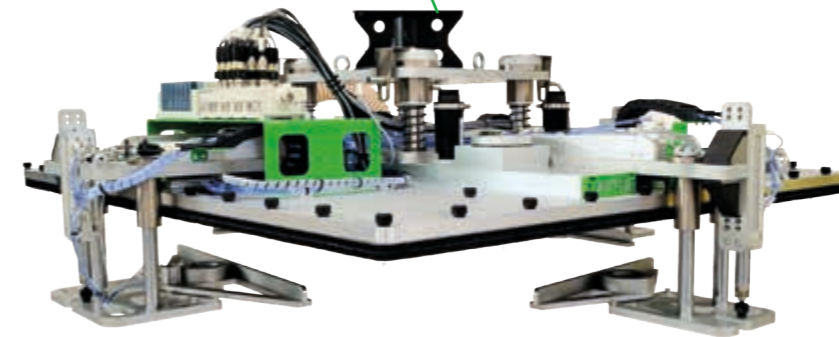

ACCORDING TO YOUR REQUEST
Mechanical accessories like side clamps can be added to your need.

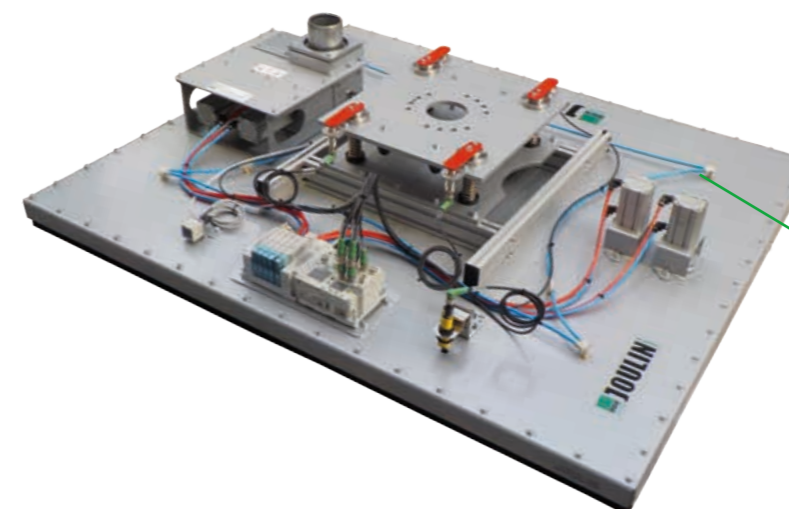
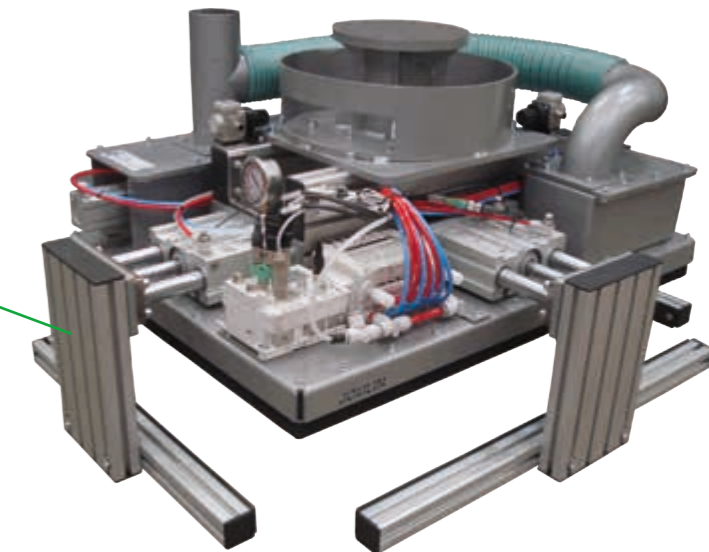

OUR SOLUTIONS
From the gripper alone to a complete plug & play solution.



Options

How to customize

ROBOT ATTACHMENT

Diffrent versions available, fixed or mobile. Easy to install on robot. Allows to compensate layers deformation with the foam.
Custom height possible.

ROTATING CONNECTION

Built on picking module or directly on the gripper.

ANTI-COLLISION SYSTEM / COMPLIANCE

Compensates layers deformations.
Allows programming of heights of layers.
Easy to install on robot.

PNEUMATIC MODULE

Regroups compressed air distribution and input/output sensors.
Many communication protocols available:
CC-Link, Ethernet/IP, etherCAT, Pro Net, Pro Bus DP, Device Net, Can Open.

ZONING

Used for the release of partial layers according to precise palletizing schemes.
Many versions available.

PALLET HOOKS

With rotating cycinders for a retractable assembly.

BLOW-IN – BLOW-THROUGH

Blows compressed air inside the gripper for a quick release of large layers.
Blows compressed air through the gripper directly onto the products for quick release of slip sheets or lightweight products.
With compressed air or with flow-reverser option (blower).

PRESENCE DETECTION

M12 photo-electric proximity sensor or inductive proximity sensors.
Ultrasonic sensors for a fast approach on the layers.
Laser sensors for detecting layers.

CLAMPS

Supports products during acceleration. Layers conformation.

VACUUM OR DETECTION SENSORS

Presence detection: M12 photo-electric proximity sensor or inductive proximity sensor with plunger
Fast approach: Ultrasonic sensor detecting the layer.

SLIP SHEETS PICKING

By retractable or rotating cylinder for minimum bulk.

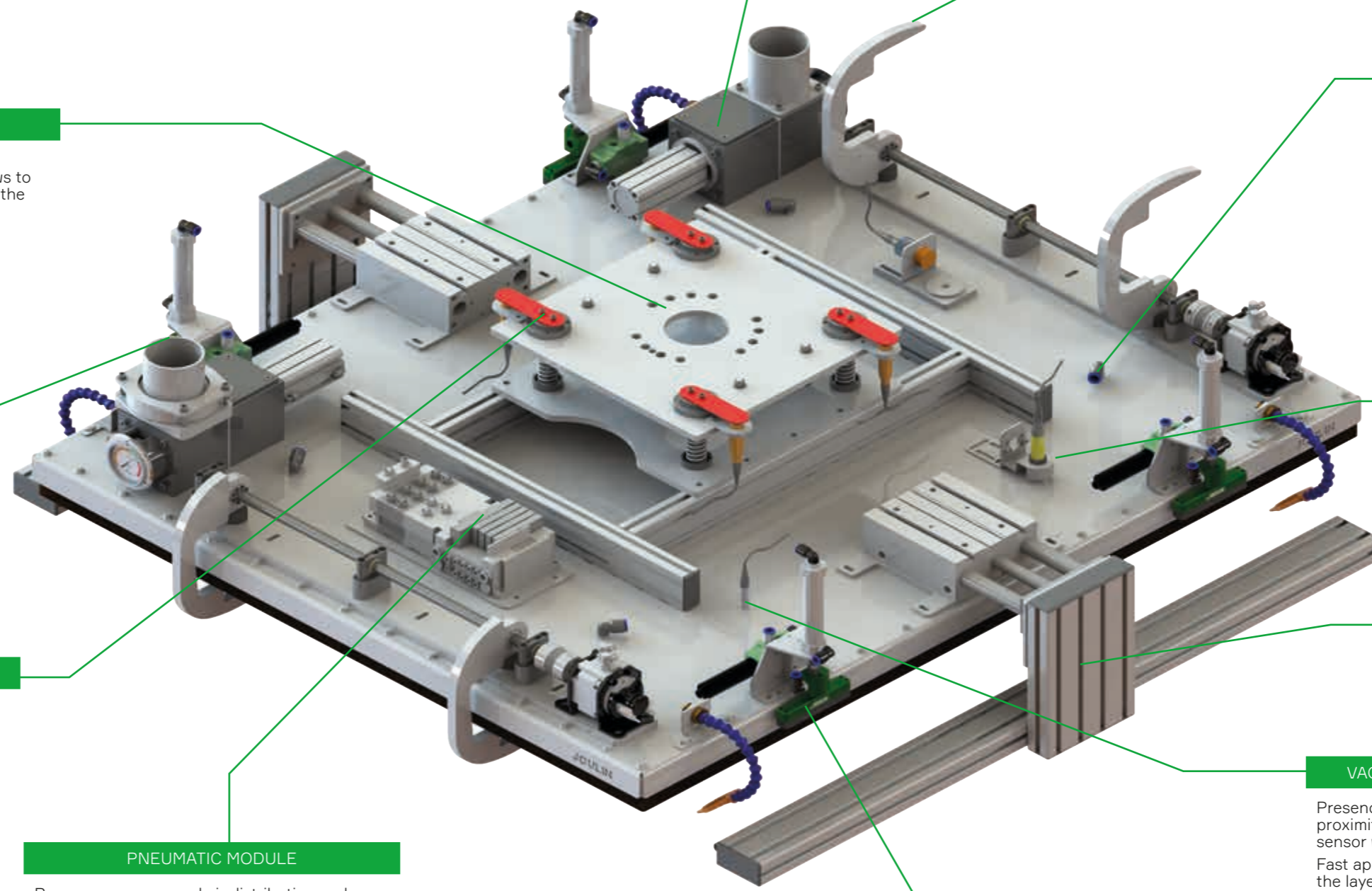



Handling/Palletizing all products

All products, all industries

Whether your products are light or heavy, wrapped or inside a carton, packaged by units or layers, on a pallet or conveyor, dry or wet, we have the gripper that's capable of handling it.

A complete range of standard grippers and the ability to design on request « custom » grippers allows us to provide you the most suitable solution.

From our industrial plants in France, Italy and the USA, we have supplied thousands of installations all over the world.

We Handle it All !

Applications



CARTON

- Handling of cartons, pallets and slip sheets.
- Partial, uneven layers.
- Multiple product dimensions.
- Products with flaps, glues or straps.
- Dusty environment.



GLASS JARS

- Infeed / outfeed of glass jar layers.
- Picking / releasing of slip sheets.
- Different shapes and dimensions of products on the same application.
- Uneven layers.



MATERIALS

- Building materials (bricks, cinderblocks, tiles...).
- Partial, uneven layers.
- Different sizes of products on the same line.
- Dusty environment.



BAGS

- Stacking or destacking of bags containing cement, shavings, pellets ... by layer or by unit
- Several materials and filling
- Different sizes of bags
- Dusty environment.

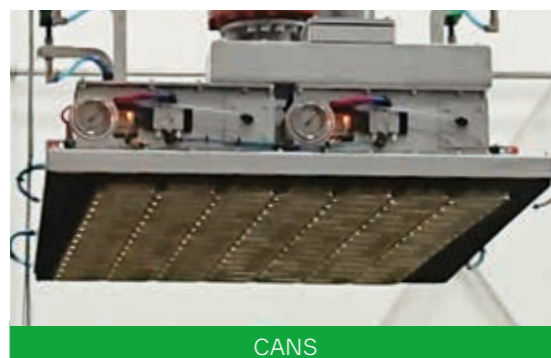

CANS

- Palletizing or depalletizing layers of cans.
- Uneven layers.
- Steel, aluminum... products.
- Different sizes of cans.
- Handling of slip sheets.



TINS, BARRELS AND BUCKETS

- Handling of plastic, steel, aluminum... containers
- Difficult or thick lids, significant difference in level between the center of the lid and the edge.
- Different sizes of products on the same line.
- Products wrapped under a heat-film.



WRAPPED PRODUCTS

- Palletizing or depalletizing layers of wrapped, packaged... products in the middle or end of production line.
- Uneven layers.
- Different sizes of products.
- Handling of slip sheets and pallets.



WOOD

- Handling of boards, doors, furniture elements, parquet boards, chipboard...
- Different sizes of products.
- Uneven layers.
- Elements with openings, grooves, etc. randomly placed on the product.
- Dusty environment.



Foams

Performance guaranteed

A suitable foam (porosity, elasticity...) is the guarantee of **efficient economical handling** (durability and maintenance costs).

Our expertise and cutting sites in Europe and the USA allow us to guarantee quality at the best price and the most efficient service.

Our experience from multiple industries allows us to develop and produce the most suitable foam for your gripper and the products to be handled.

BENEFITS

- Different thicknesses
- Different patterns
- Better foam adhesive performance
- Different materials : EPDM, latex, silicone, ...
- **Quick delivery**

Standard or custom production

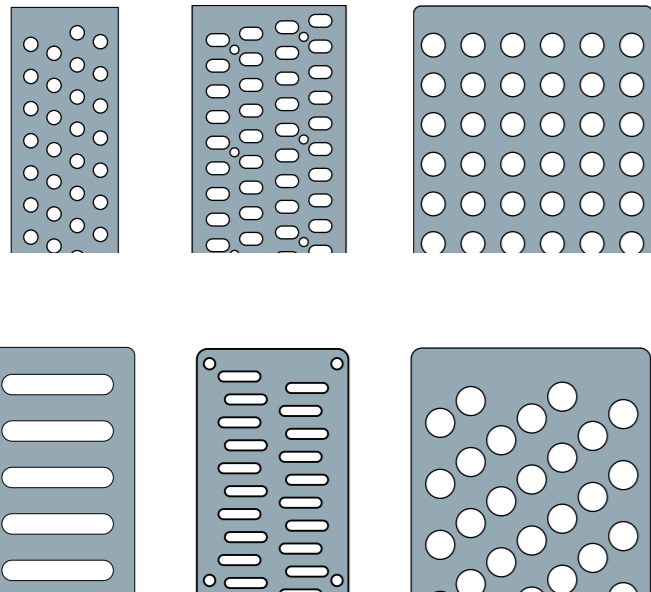

High quality adhesive foam

Quick foam changing

EASY FOAM FOAM VACUUM GRIPPER

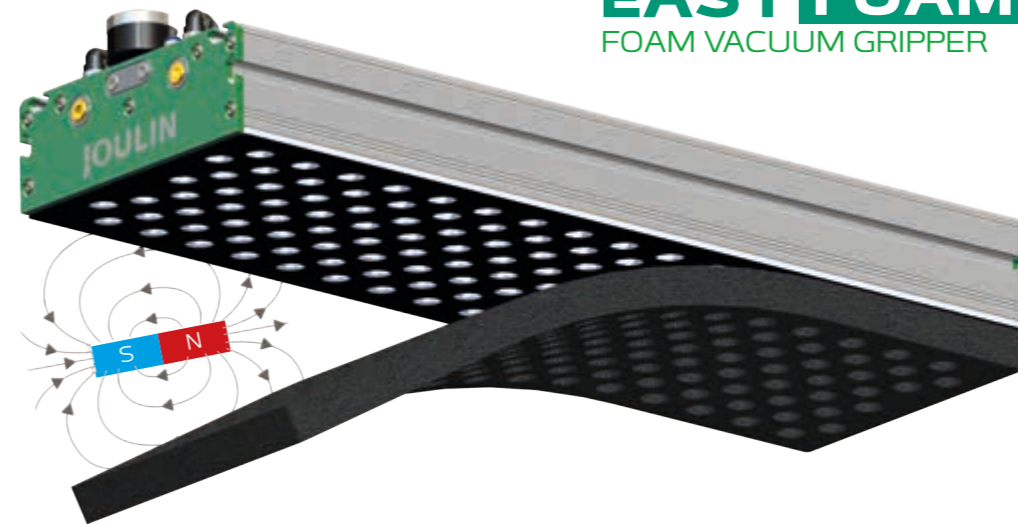

New ultra quick foam changing system:
EasyFoam

Interchangeable support plates
for quick change of foam.

CONCEPT

- Fast and easy removal of foam from the gripper
- Easy to install on existing gripper(s)
- Reduces maintenance time and cost
- No adhesive to remove at foam change

BENEFITS

- Easy access to the gripper for maintenance and cleaning
- Can be removed/replaced an unlimited number of times
- Independent filter for dusty environments

EASY TO ADAPT

- Adaptable to all brands of existing grippers
- All foam styles / brands
- Easily clean and replace the filter by removing the magnetic foam

zoom in...

Spare parts

For each of our vacuum gripper, we stock all the spare parts (wear and maintenance) you need to maintain it.



HOSE



SEAL



VACUUM GENERATORS



A partner at your side

We develop long-term relationships with our customers. Our agile organization and industrial sites in France, Italy and the USA allow us to adapt and answer to the specificities of your needs.

Our values, practiced daily, are reliability, professionalism and proactivity.

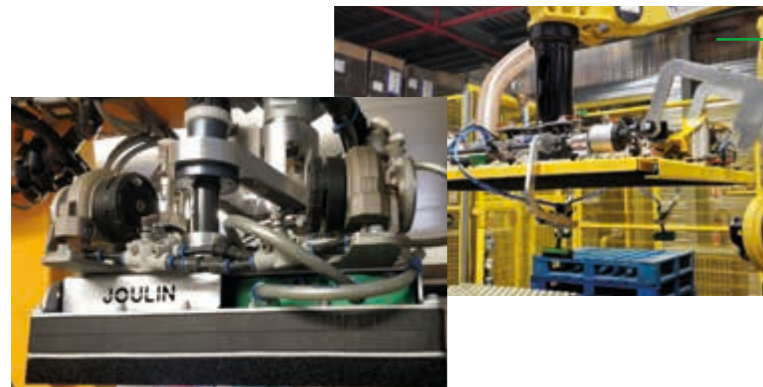
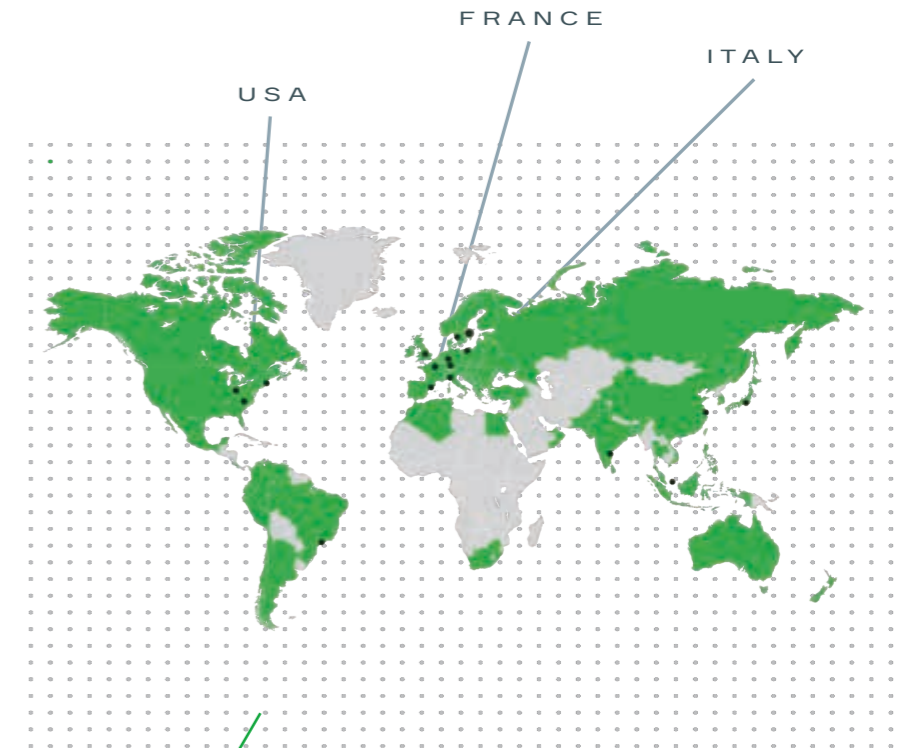

VACUUM GRIPPERS

Widest range of standard in the world.
From cobot to large palletizer.



CUSTOM

Our speciality (thousands of projects).
Dedicated engineering teams in Europe and the USA for maximum reactivity.



TECHNOLOGY

Not sensitive to dust or debris.
Up to 50% energy savings.
Exclusive patented technologies.



PROXIMITY

Industrial sites in Europe and the USA.
Commercial presence in 100 countries.



REACTIVITY

Dedicated experts and project engineers.
Online configurators.



RELIABILITY

60 years of experience.
Thousands of projects in more than 100 countries.

The real right solution

We have the largest portfolio of products and technologies for vacuum grippers on the market. Working with us is the guarantee to get a real optimized solution as well as high level service all around the globe.

Reliability

60 years of experience
Thousands of projects in more than 80
countries

Proactivity

Dedicated Experts & Project Engineers
Online configurators

Proximity

Industrial sites in Europe and USA
Commercial presence in 100 countries

PRODUCTION SITES

USA

Hickory (NC)
2551 hwy70 SW,
Hickory, NC 28602

Xenia (OH)
1200 S Patton St,
Xenia, OH 45385

France

Etampes
17 avenue des Grenots
91150 Etampes

Italy

Montegrotto
Via del Commercio, 3,
35036 Montegrotto,
Terme PD

AMERICAS

Brazil

Sao Paulo
+55 (0)11-449 290 50
info-brasil@piab.com

Canada

Hingham (MA, US)
+1 800 321 7422
info-usa@piab.com

Mexico

Hingham (MA, US)
+1 781 337 7309
info-mxca@piab.com

USA

Hingham (MA)
+1 800 321 7422
info-usa@piab.com

ASIA

China

Shanghai
+86 21 5237 6545
info-china@piab.com

Hu Zhou City (Airbest)
+86-572-6388266
grace@airbest.com

India

Pune
+91 8939 15 11 69
info-india@piab.com

Japan

Tokyo
+81 3 6662 8118
info-japan@piab.com

Singapore

Singapore
+65 6455 7006
info-singapore@piab.
com

EUROPE

France

Lagny sur Marne
+33 (0)16-430 82 67
info-france@piab.com

Etampes (Joulin)
+33 (0)1 69 92 16 16

Germany

Butzbach
+49 (0)6033 7960 0
info-germany@piab.com

Italy

Torino
+39 (0)11-226 36 66
info-italy@piab.com

Montegrotto (Kenos)
+39 (0)49 8741384
info-italy@piab.com

Poland

Gdansk
+48 58 785 08 50
info-poland@piab.com

Spain

Barcelona
+34 (0)93-633 38 76
info.spain@piab.com

Sweden

Danderyd (HQ)
+46 (0)8-630 25 00
info-sweden@piab.com

Helsingborg
+46 042-400 45 80
se-sales@piab.com

Karlstad
+46 054 55 80 90
se-sales@piab.com

Täby
+46 544 409 00
se-sales@piab.com

Mullsjö
+46 392 497 85
sales@avac.se

United Kingdom

Loughborough
+44 (0)15-098 570 10
info-uk@piab.com

Robotic Gripping is also...



Modular EOAT components
and mechanical EOAT
solutions

Stacking – Destacking systems
for all handling in wood industry



Do you want to know more?

Take a look at www.piab.com www.joulin.com