

人と夢をつなぐクリーンテクノロジー

# KOGANEI

<http://www.koganei.co.jp>

Catalog No.BK-P408

**NEW**  
Products

## Static Electricity Removing Unit Ionizer

# Air gun type

## DTY-ELG41

### Change the shape and handling, to support various situations!

**NEW** Provides the optimal dust removal for the target workpiece.

Lighting LED equipped as standard



LED ON

Air gun shape



# Switch

Straight shape



DTY-ELG41

● Continuous blow

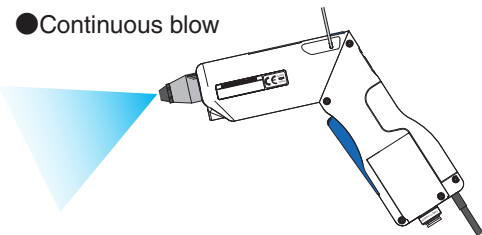

DTY-ELG41-PAU

● Pulse blow

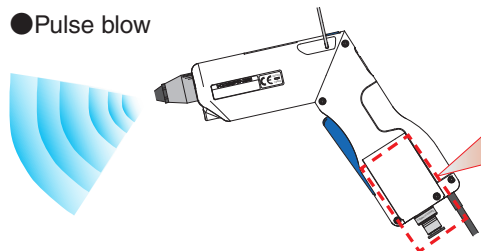

Pulse blow unit built in

### Reduce air consumption!

Reduces compressed air consumption to contribute to energy saving at the plant.

# Static Electricity Removing Unit Ionizer

## Air gun type

### DTY-ELG41

#### □ Features

- The product is designed for easy holding, and has a 185g [6.53 oz] light weight body. (DTY-ELG41)  
**10% reduction in weight (compared to our products)**
- A high-frequency AC method provides high efficiency of electrostatic charge removal and outstanding ion balance.
- Highly flexible, flex-resistant cable is used for connection. (Main unit cable only)
- A separate controller is unnecessary because a valve and ion generator is built in.
- For -PAU, pulsed air improves energy saving/dust removal efficiency. (The pulse blow frequency is variable in the range of 5 to 15Hz.)  
The IN port and the pulse blow unit are detachable. Options (sold separately) are replaceable.

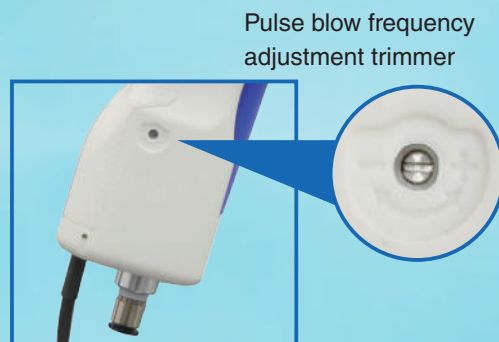

- Equipped with a lighting LED as standard. The high-brightness LED helps to prevent overlooking small foreign contaminants, and check foreign contaminants on hole bottoms, etc.



The Lighting LED switch enables you to select among normally OFF (OFF)/normally ON (ON)/level sync (SYNC).





## □ Features

- You can bend the main unit to switch the ionizer between air gun shape and straight shape.
- When the ionizer is in straight shape, you can use it by suspending it.
- \* The suspension bracket is movable.

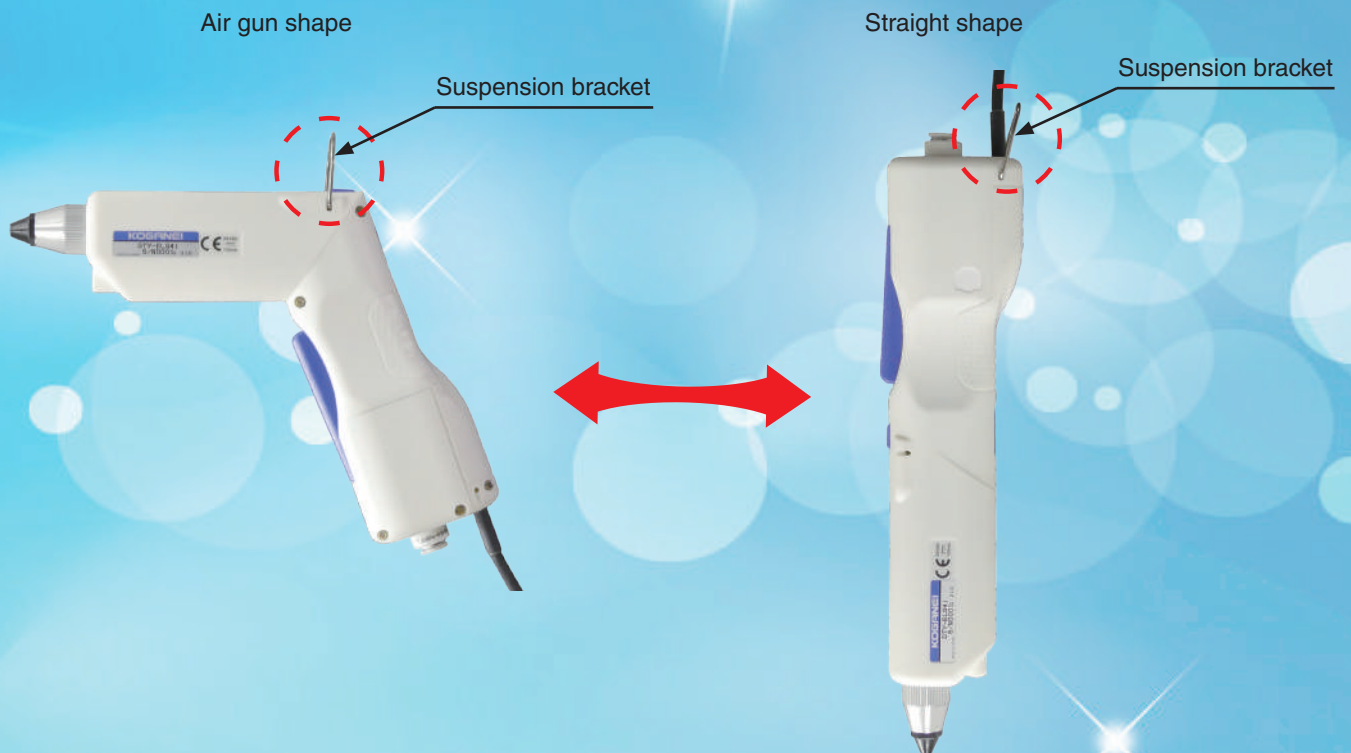

- The extension nozzle enables you to perform electrostatic charge removal and dust removal in narrow spaces.



## Applicable examples

- Electrostatic charge removal and dust removal work by suspending the ionizer from the ceiling

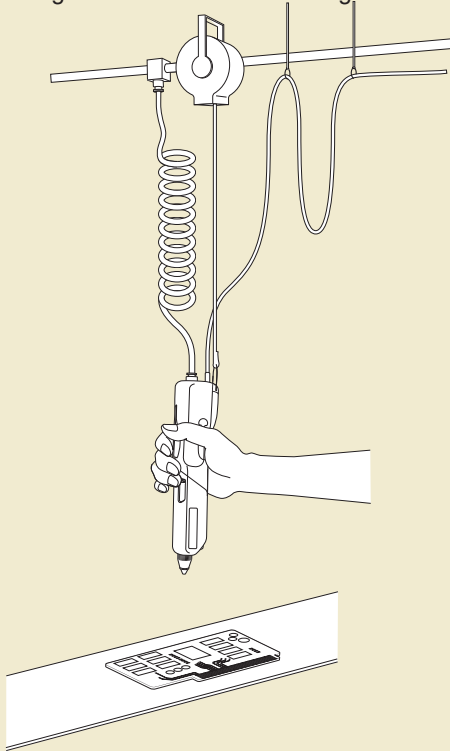

- Electrostatic charge removal and dust removal work in the ceiling of a box

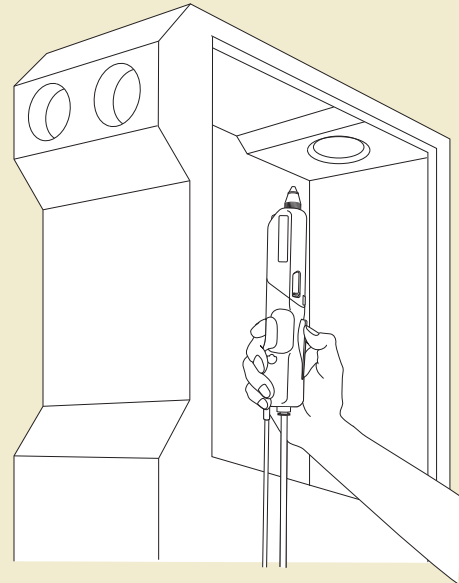

## Switching method

Air gun shape

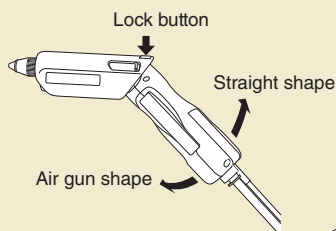
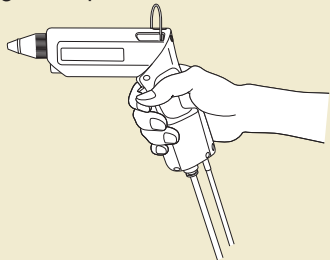

Straight shape

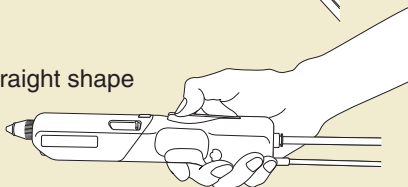

When the ionizer is in air gun shape, pressing and holding down the lock button and turning the main unit clockwise switches the ionizer to straight shape. When the ionizer is in straight shape, pressing and holding down the lock button and turning the main unit counterclockwise returns the ionizer to air gun shape.

- \* When the ionizer is in air gun shape, you cannot turn the main unit counterclockwise.
- \* When the ionizer is in straight shape, you cannot turn the main unit clockwise.

- Switch the ionizer to air gun shape before use

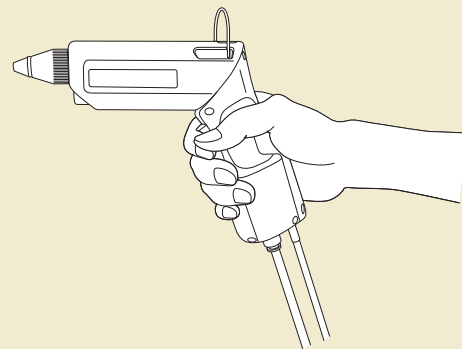

- Switch the ionizer to straight shape before use

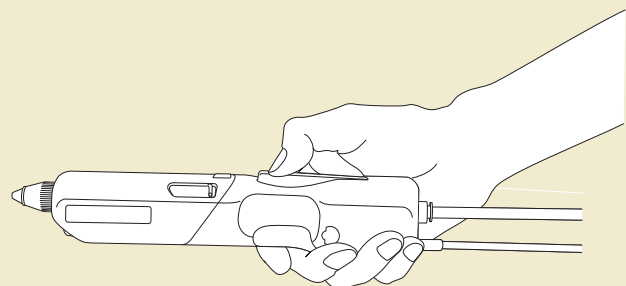



# Specifications

Item	Model	DTY-ELG41-□
Input voltage	V	DC24±5%
Current consumption	mA	100 or less
Output voltage	kV	Approx. 2.5 (high frequency type)
Display	Power/discharge	Power ON: Indicator LED (green) flashing Discharge: Indicator LED (green) ON
	Alarm	Alarm indicator LED (red) ON
Lighting LED		White LED
Lighting LED switch		Normally OFF/Normally ON/Lever sync
Outer dimensions	mm [in.]	For gun shape: 177.3(L)×32(W)×127.9(H) [6.980(L)×1.260(W)×5.035(H)] For straight shape: 222.2(L)×32(W)×50(H) [8.748(L)×1.260(W)×1.969(H)] (not including protrusions)
Mass	g [oz]	DTY-ELG41: 185 [6.53] DTY-ELG41-PAU: 235 [8.29] (without cables)
Ion balance *1	V	±15
Pulse frequency *2	Hz	5 to 15
Ozone generation amount *3	ppm	0.04 or less
Medium*4		Air (clean air, water vapor and oil removed)
Operating air pressure range	MPa [psi]	DTY-ELG41: 0.05 to 0.6 [7 to 87] DTY-ELG41-PAU: 0.2 to 0.6 [29 to 87]
Operating Environment		Indoors: 0 to 40°C [0 to 104°F]/65% or less (non-condensation)
Material		Body: PBT, Nozzle: PPS
Accessories		AC Adapter, Instruction Manual

\*1: Distance 100mm [3.937 in.] from nozzle port, pressure 0.4MPa [58 psi], standard nozzle

\*2: Depending on the piping conditions and the nozzle used, the frequency/flow characteristics may differ.

\*3: Distance 200mm [7.874 in.] from nozzle port, pressure 0.2MPa [29 psi]

\*4: Be sure to supply air when using.

Remark 1: Ion balance is measured according to our measurement conditions.

2: Do not use other nozzles other than the dedicated one. Do not alter the nozzle. Doing so could cause the product to fail, stop working, and break.

3: The tube must be φ6 in diameter and be 3m [9.840 ft] or less in length. Otherwise, the electrostatic charge removal performance/pulse blow operation could be affected.  
Do not replace the fitting.

## Order codes

### ● Main unit

#### DTY-ELG41-□

**Blank:** No pulse blow unit  
**PAU:** Pulse blow unit built in



**NOTE** -PAU cannot perform continuous blow. To use continuous blow, select "Blank".



Cable length: 2000mm [78.740 in.]



#### AC adapter (accessory)

Rating  
Input : AC100 to 240V  
50/60Hz 0.3A  
Output: DC24V 0.5A  
Cable length: 1200mm [47.244 in.]

### Special tool for replacing discharge needle

NOTE: Only bits are for sale.

#### DRY-ELB21

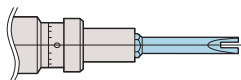

Shape of jig for replaceable bit

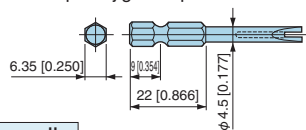

### Replacement of discharge needle

When replacing the discharging needle, use the dedicated tool **DRY-ELB21** in combination with a torque driver. The dedicated tool is designed not to damage the discharge needle or the threaded part of the main body. Replacing with another tool may cause damage to the discharge needle and main body, etc. The tightening torque during replacement must be 15 to 20N·cm [0.111 to 0.148 ft·lbf]. If the discharge needle is replaced without using the dedicated tool and the discharge needle, main body, etc. are damaged, the warranty will not cover.

NOTE: When replacing the nozzle or take off the nozzle for the maintenance of the discharge needle, tighten the nozzle securely by hand without using a tool. Tightening the nozzle with excess force could damage the threaded portion, etc.

### ● Options (sold separately)

#### Replacement discharge needle (unit: 5 per set)

#### DTY-ZEM-G31



#### Replacement nozzle

#### DTY-Z□-G31

**N1:** Replacement nozzle  
**N2:** Extension nozzle



#### Pulse blow unit

#### DTY-ZPA-G31



**NOTE** The options are common to the Static Electricity Removing Unit Ionizer-Air gun types DTY-ELG31 and DTY-ELG41. For information about DTY-ELG31, see "Catalog No.P407".

AC adapter (1200mm [47.244 in.])

#### DTY-ZPS-G31



#### IN port

#### DTY-ZNP-G31



Label to apply to the pulse blow frequency adjustment trimmer section attached

\* Label used to seal the trimmer section when removing the pulse blow unit.

#### Extension cable

#### DTY-Z□-G31

**CE3:** Extension cable 3m [9.840 ft]  
**CE5:** Extension cable 5m [16.400 ft]

\* Flex-resistant cable

## Static charge removal characteristics

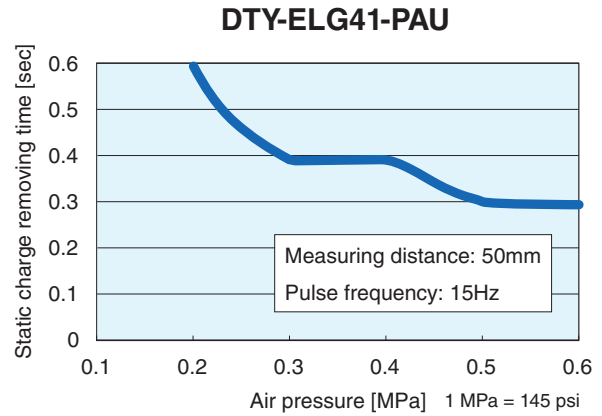
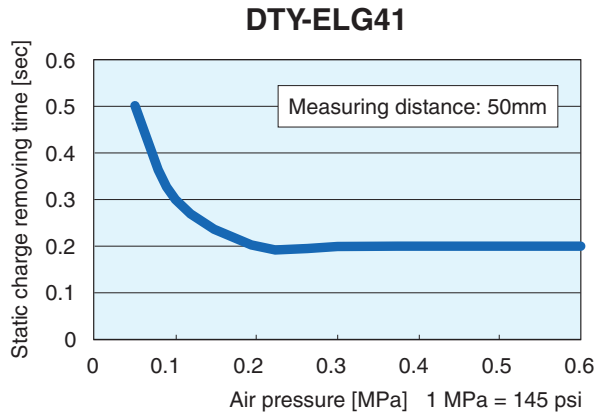

Note 1: Measured using a 150 mm [5.906 in.], 20pF charged plate monitor.

Note 2: The static charge removing time is the decay time from  $\pm 1000V$  to  $\pm 100V$ . (Standard nozzle)

Note 3: The above data are actual measurement valve and are not guaranteed.

## Flow characteristics

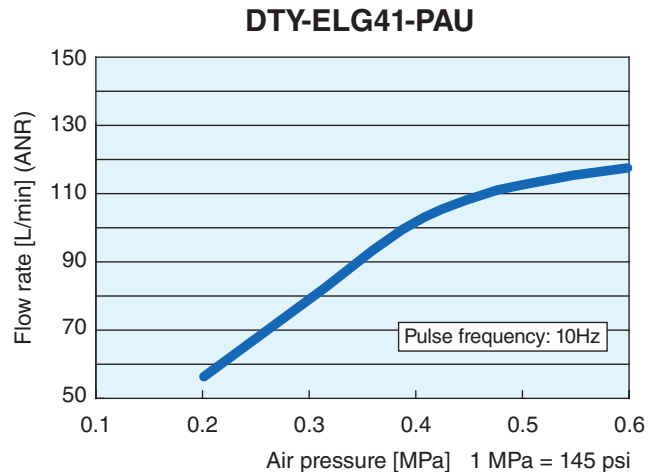
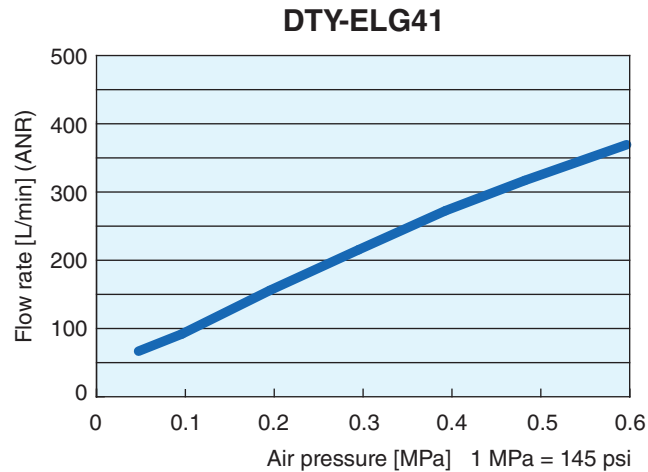

Note 1: According to our test conditions ①.

2: The above data are actual measurement valve and are not guaranteed.

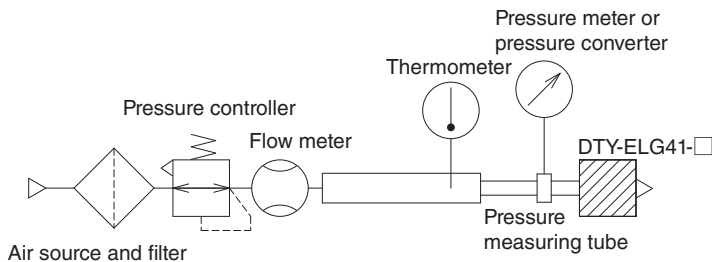

## Warning

- Do not point the tip of the nozzle at a person.
- Use safety glasses and earplugs because blowing air could blow objects into people's eyes or cause hearing loss.



## Caution

Prior to using the product, be sure to read "Safety precautions" on page 5 of "Catalog No.R0009 Static Electricity Removing Unit" catalog.

● Main unit

**DTY-ELG41**

**DTY-ELG41-PAU**

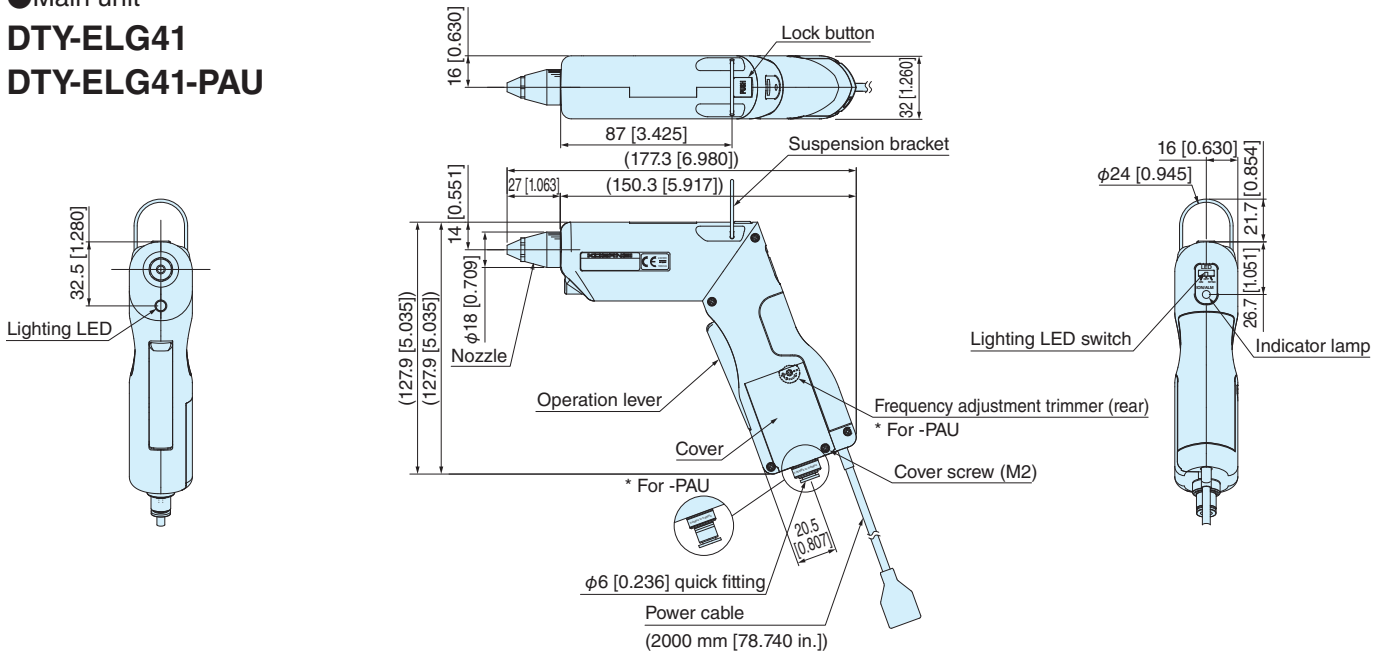

For gun shape

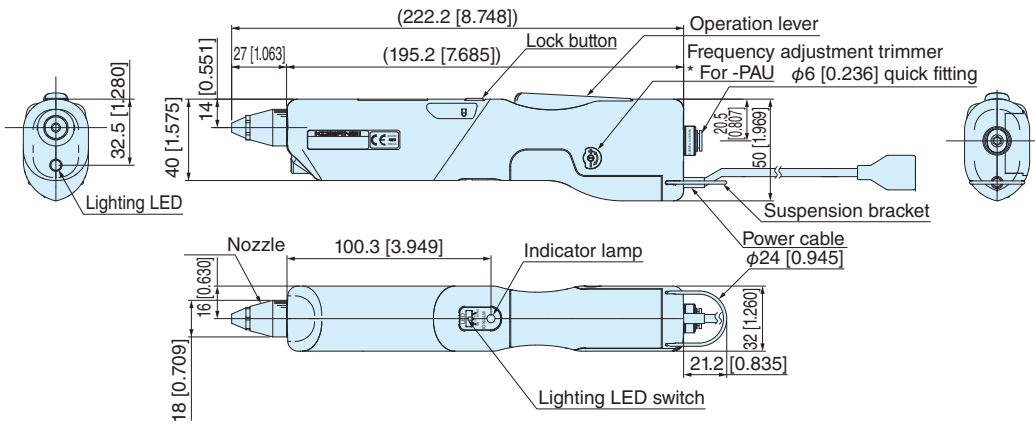

For straight shape

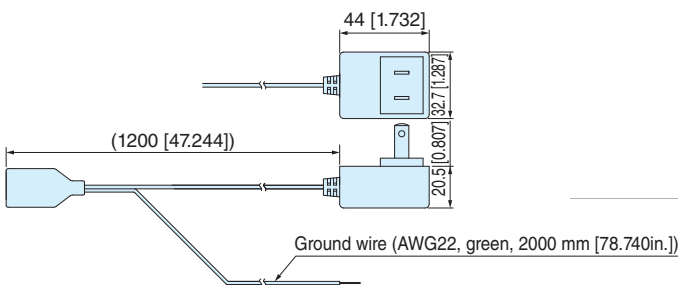

AC adapter (accessory)

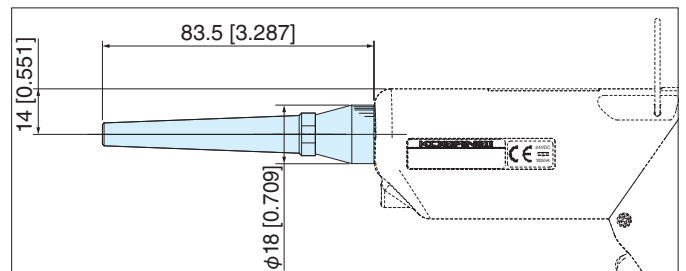

When the extension nozzle is attached



● AC adapter

**DTY-ZPS-G31**

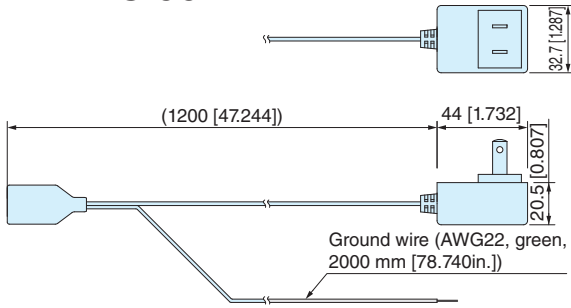

● Extension cable

**DTY-Z□-G31**

- CE3: Extension cable 3m [9.840 ft]
- CE5: Extension cable 5m [16.400 ft]

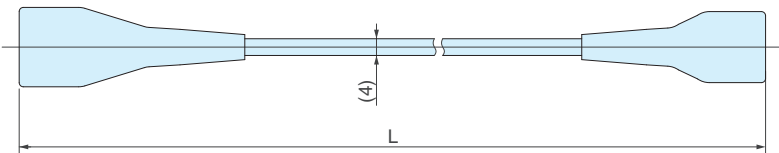

L dimensions

Model	L(mm [in.])
DTY-ZCE3-G31	3000 [118.1]
DTY-ZCE5-G31	5000 [196.9]

● Nozzle

**DTY-Z□-G31**

- N1: Replacement nozzle
- N2: Extension nozzle

Replacement nozzle

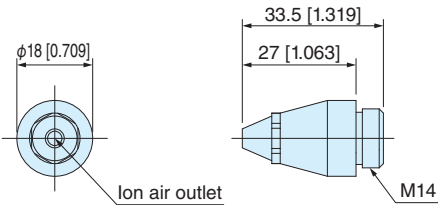

Extension nozzle

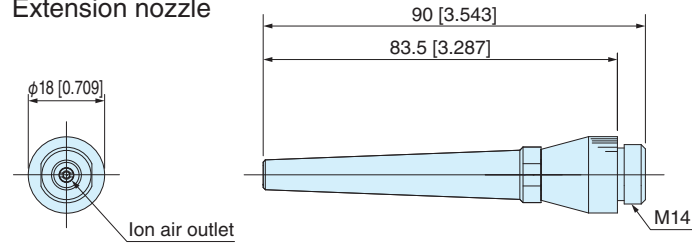



### General precautions

1. Make sure that no excessive external force is applied to the product.
2. Do not disassemble or alter the product.
3. Protect the product from ultraviolet rays, rain, and wind.

#### Mounting

1. When installing each device, make sure that it is not stained with water or oil and is free from high temperature and humidity. In particular, avoid a location where condensation occurs.

#### Wiring

1. Be sure to ground the ground wire to frame ground (F.G.).
2. If using any device that can generate noise (such as a switching regular and an inverter motor) around the product, be sure to ground the frame ground (F.G.) terminal of the device.
3. After the end of wiring, check if the connections are correct.

#### Notes on use

1. Be sure to turn OFF the power before inspection, cleaning, and maintenance.
2. In the event of a failure, adjustment and repair are necessary. Be sure to contact us.
3. Maintenance is very important for performance retention. Conduct periodic maintenance according to the Instruction Manual for the product.
4. Check any devices and parts (in particular, low ozone resistant parts such as NBRs) used near the ionizer to see if they are ozone-deteriorated.
5. Do not use this product with any moving parts that give vibration or impact.
6. Do not use the AC adapter cable or the power and signal lines attached to this product with any moving parts. Doing so could cause the cable and lines to break.
7. Use this product within the pulse frequency range mentioned in the specification table.

### Warranty and disclaimer

#### 1. Warranty Period

The warranty period of KOGANEI CORP. products is one year from the date of delivery.

\* Some products have a two-year warranty period. For details, contact the nearest KOGANEI CORP. office or Overseas Department.

#### 2. Warranty scope and disclaimer

- (1) If a failure attributable to KOGANEI CORP. is found in a product purchased from KOGANEI CORP. and an authorized retailer/dealer during the warranty period, KOGANEI CORP. will repair or replace it free of charge. For some products, a service life, such as the number of operations, may be specified in their warranty periods. For details, contact the nearest KOGANEI CORP. office or Overseas Department.
- (2) The warranty of each KOGANEI CORP. product shall apply to that product alone. Consequently, KOGANEI CORP. shall in no way be responsible for any incidental damage (including costs incurred for the repair and replacement of the product) attributable to any failure of the KOGANEI CORP. product, decrease in function, or decrease in performance.
- (3) KOGANEI CORP. shall in no way be responsible for any damage induced by any failure of the KOGANEI CORP. product, decrease in function, or decrease in performance or any damage to other devices attributable to the same.
- (4) KOGANEI CORP. shall in no way be responsible for any damage due to use or storage beyond the range in the product specifications mentioned in the KOGANEI CORP. catalog and the Instruction Manual or due to any acts not mentioned in the mounting, installation, adjustment, maintenance, and other notes.
- (5) KOGANEI CORP. shall in no way be responsible for any damage caused by any failure of the KOGANEI CORP. product due to any fire not attributable to KOGANEI CORP., any natural disaster, any act by a third party, the intention or negligence of the customer, etc.



# Limited Warranty

KOGANEI CORP. warrants its products to be free from defects in material and workmanship subject to the following provisions.

**Warranty Period** The warranty period is 180 days from the date of delivery.

**Koganei Responsibility** If a defect in material or workmanship is found during the warranty period, KOGANEI CORP. will replace any part proved defective under normal use free of charge and will provide the service necessary to replace such a part.

**Limitations**

- This warranty is in lieu of all other warranties, expressed or implied, and is limited to the original cost of the product and shall not include any transportation fee, the cost of installation or any liability for direct, indirect or consequential damage or delay resulting from the defects.

- KOGANEI CORP. shall in no way be liable or responsible for injuries or damage to persons or property arising out of the use or operation of the manufacturer's product.

- This warranty shall be void if the engineered safety devices are removed, made inoperative or not periodically checked for proper functioning.

- Any operation beyond the rated capacity, any improper use or application, or any improper installation of the product, or any substitution upon it with parts not furnished or approved by KOGANEI CORP., shall void this warranty.

- This warranty covers only such items supplied by KOGANEI CORP. The products of other manufacturers are covered only by such warranties made by those original manufacturers, even though such items may have been included as the components.

The specifications are subject to change without notice.

URL <http://www.koganei.co.jp>

E-mail: [overseas@koganei.co.jp](mailto:overseas@koganei.co.jp)



## KOGANEI CORPORATION

### OVERSEAS DEPARTMENT

3-11-28, Midori-cho, Koganei City, Tokyo 184-8533, Japan  
Tel: 81-42-383-7271 Fax: 81-42-383-7276

### KOGANEI INTERNATIONAL AMERICA, INC.

48860 Milmont Drive, suite 108C, Fremont, California 94538  
Tel: 1-510-744-1626 Fax: 1-510-744-1676

### SHANGHAI KOGANEI INTERNATIONAL TRADING CORPORATION

Room 2601-2602, Tongda Venture Building No.1, Lane 600, Tianshan Road,  
Shanghai, China(200051)  
Tel: 86-21-6145-7313 Fax: 86-21-6145-7323

### TAIWAN KOGANEI TRADING CO., LTD.

Rm. 2, 16F, No88, Sec. 2, Zhongxiao E. Rd., Zhongzheng Dist., Taipei City 100,  
Taiwan (ROC)  
Tel: 886-2-2393-2717 Fax: 886-2-2393-2719

### KOGANEI KOREA CO., LTD.

A-3001, Heungdeck IT Valley Bldg., Heungkeck 1-ro, 13, Giheung-gu,  
Yongin-si, Gyeonggi-do, 446-908, KOREA  
Tel: 82-31-246-0414 Fax: 82-31-246-0415

### KOGANEI (THAILAND) CO., LTD.

555 Rasa Tower 1, 12th Floor, Unit 1202 and 1207, Phaholyothin  
Road, Chatuchak, Chatuchak, Bangkok 10900 Thailand  
Tel: 66-2-937-4250 Fax: 66-2-937-4254

### KOGANEI AUTOMATION (MALAYSIA) SDN.BHD.

Suite 29-2, Level 29, Menara 1MK, No.1, Jalan Kiara, Mont Kiara  
50480, Kuala Lumpur, Malaysia  
Tel: 60-12-537-7086

### KOGANEI ASIA PTE. LTD.

69 Ubi Road 1, #05-18 Oxley Bizhub, Singapore 408731  
Tel: 65-6293-4512 Fax: 65-6293-4513