

1 ANELLO DI SOSTEGNO
LOCK RING

2 PINZA DI AGGRAFFAGGIO
CRIMPING GRIPPER

3 DISTANZIALE DI FERMO
LOCK RING

4 ANELLO SPINGITORE
THRUST SLEEVE

5 O-RING DI TENUTA
O-RING SEAL

6 BASE GIREVOLE
SWIVEL BASE

7 CORPO DEL RACCORDO
FITTING BODY

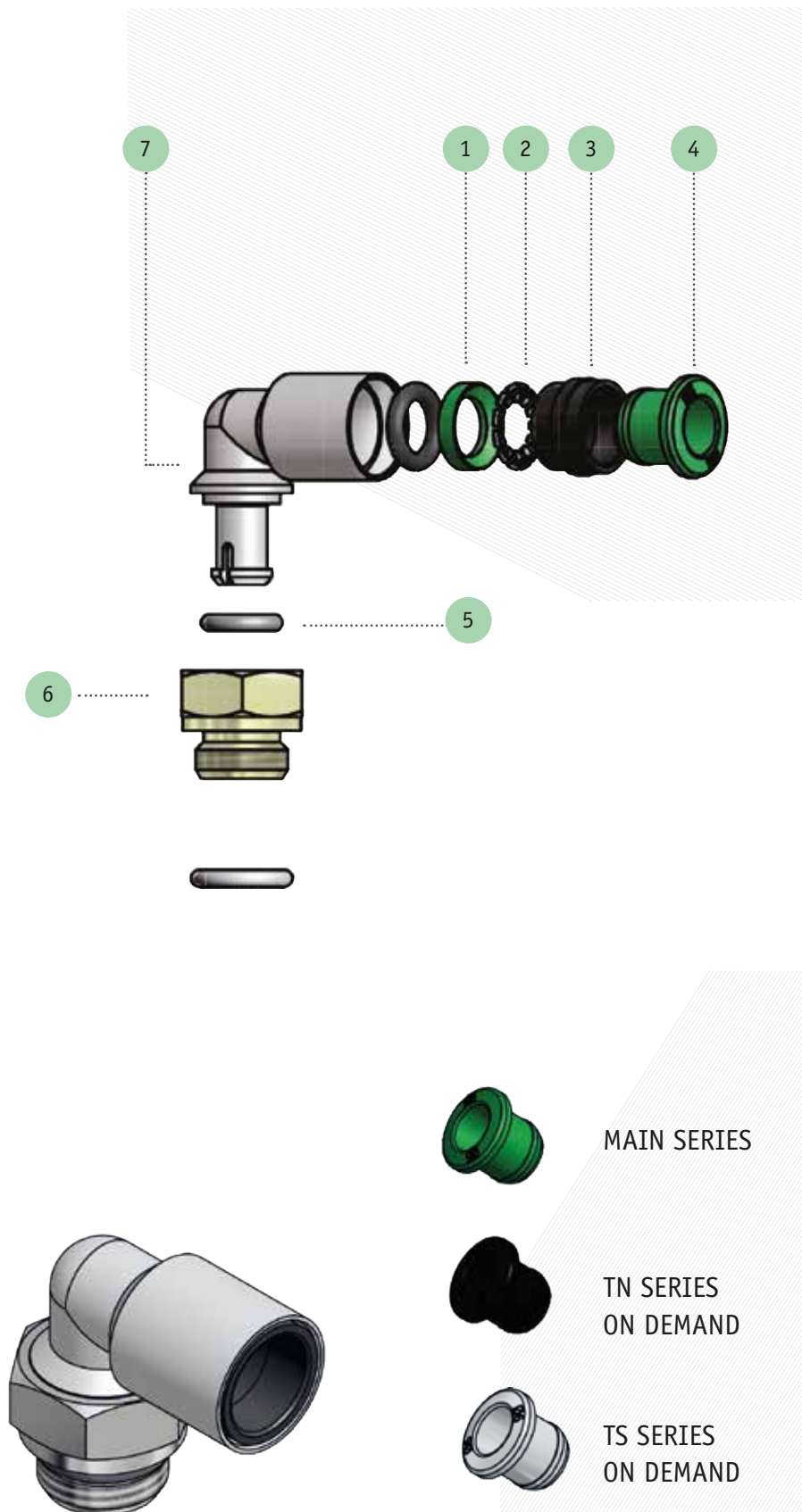

ART. T01

Diritto filetto cilindrico maschio con O-Ring
Straight male adaptor (parallel)

CODICE	ØD	G	ØC	ØB	H	L			
T0104M10	4	M10x1,5	2,5	14,0	7,5	21,3	10	2,5	50
T010418	4	1/8	2,5	14,0	5,5	19,0	10	2,5	50
T010414	4	1/4	2,5	17,5	6,5	20,8	10	2,5	50
T0106M10	6	M10x1,5	4,0	14,0	7,5	26,8	12	4,0	50
T010618	6	1/8	4,0	14,0	5,5	24,5	12	4,0	50
T010614	6	1/4	4,0	17,5	6,5	26,0	12	4,0	50
T0108M10	8	M10x1,5	6,0	14,0	7,5	28,1	14	5,0	50
T010818	8	1/8	5,0	14,0	5,5	25,7	14	5,0	50
T010814	8	1/4	6,0	17,5	6,5	27,2	14	6,0	50
T011014	10	1/4	7,0	17,5	6,5	28,7	18	7,0	50

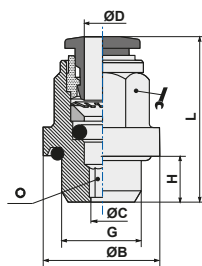

ART. T03

Diritto innestabile
Straight connector

CODICE	ØD	ØD1	ØC	ØB	ØB1	L	
T030400	4	4	3	9,5	9,5	32,0	50
T030406	4	6	3	9,5	11,5	32,5	50
T030600	6	6	5	11,5	11,5	35,6	50
T030608	6	8	5	11,5	13,5	36,0	50
T030800	8	8	7	13,5	13,5	38,0	50
T030810	8	10	7	13,5	17,0	32,5	50
T031000	10	10	9	17,0	17,0	42,3	50
T031012	10	12	9	17,0	20,0	44,0	50
T031200	12	12	10	20,0	20,0	46,2	25

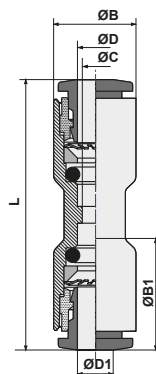

ART. T04

Gomito innestabile
L connector

CODICE	ØD	ØC	ØB	L	ØE	
T040400	4	3	9,5	17,2	3,2	50
T040600	6	5	11,5	20,8	3,2	50
T040800	8	7	13,5	23,0	3,2	50
T041000	10	9	17,0	26,4	4,3	50
T041200	12	10	20,0	28,9	4,2	25

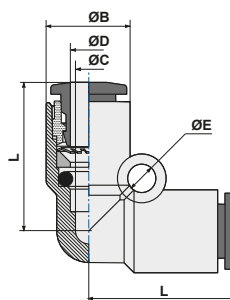

ART. T04LO

Gomito innestabile con codolo
Plug-in L connector

CODICE	ØD	ØC	ØB	L	L1	ØA	L2	
T0404L0	4	3	9,5	17,2	20,75	4	16,7	50
T0406L0	6	5	11,5	20,8	24,25	6	19,5	50
T0408L0	8	7	13,5	23,0	27,25	8	21,0	50
T0410L0	10	9	17,0	26,4	31,80	10	24,0	50
T0412L0	12	10	20,0	28,9	36,00	12	25,0	25

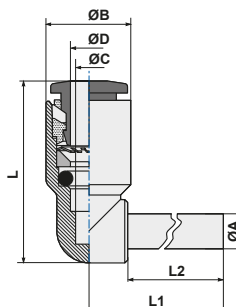

ART. T05

 T Innestabile
T connector

CODICE	ØD	ØD1	ØC	ØB	L		
T050400	4	4	3,0	9,5	17,2		50
T050604*	6	4	5,3	13,0	19,2		50
T050600	6	6	5,0	11,5	20,8		50
T050806*	8	6	7,1	14,4	22,7		25
T050800	8	8	7,0	13,5	23,0		50
T051008*	10	8	9,3	18,4	27,9		25
T051000	10	10	9,0	17,0	26,4		25
T051210*	12	10	10,0	21,0	29,9		10
T051200	12	12	10,0	20,0	28,9		10

* = di importazione - imported

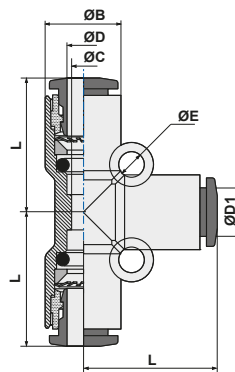
ART. T05LO

 T Innestabile con codolo centrale
Plug-in T connector (center)

CODICE	ØD	ØC	ØB	L	L1	ØA	L2	
T0504L0	4	3	9,5	17,2	20,75	4	16,7	50
T0506L0	6	5	11,5	20,8	24,25	6	19,5	50
T0508L0	8	7	13,5	23,0	27,25	8	21,0	50
T0510L0	10	9	17,0	26,4	31,80	10	24,0	25
T0512L0	12	10	20,0	28,9	36,00	12	25,0	10

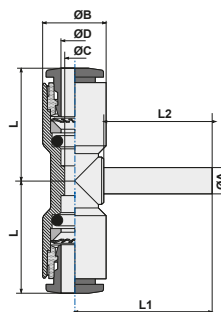
 Art. disponibile fino ad esaurimento scorte
 Item available while stocks last

ART. T05V0

 T Innestabile con codolo laterale
Plug-in T connector (lateral)

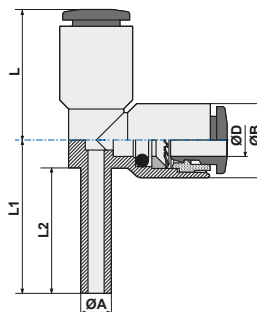
CODICE	ØD	ØB	L	L1	ØA	L2	
T0506V0	6	11,5	20,8	24,25	6	19,5	50
T0508V0	8	13,5	23,0	27,25	8	21,0	50
T0510V0	10	17,0	26,4	31,80	10	24,0	25
T0512V0	12	20,0	28,9	36,00	12	25,0	10

 Art. disponibile fino ad esaurimento scorte
 Item available while stocks last

ART. T08

Riduzione
Reducer

CODICE	ØD1	ØD	ØC	ØB	L	L1	
T080604	6	4	3	9,5	35,5	19,5	50
T080804	8	4	3	9,5	37,0	21,0	50
T081004	10	4	3	9,5	40,0	24,0	25
T081204	12	4	3	9,5	41,0	25,0	25
T080806	8	6	5	11,5	39,05	23,0	50
T081006	10	6	5	11,5	42,05	24,0	25
T081206	12	6	5	11,5	43,05	25,0	25
T081008	10	8	7	13,5	43,0	26,25	25
T081208	12	8	7	13,5	44,0	25,0	25
T081210	12	10	9	17,0	46,15	27,55	25

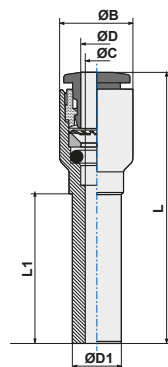

ART. T09

Tappo
Plug

CODICE	ØD	ØB	L	
T090400	4	7,0	25,0	100
T090600	6	9,5	27,5	100
T090800	8	12,0	30,0	100
T091000	10	14,0	32,5	100
T091200	12	16,0	35,0	100

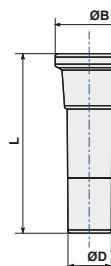

ART. T10

Passaparete
Bulkhead connector

CODICE	ØD	ØB	L	M	I _{max}		
T100400	4	9,5	32,0	11x1	8	14	50
T100600	6	11,5	36,1	14x1	8	17	50
T100800	8	13,5	38,0	16x1	10	18	50
T101000	10	17,5	42,3	20x1	12	24	25
T101200	12	20,0	46,2	22x1	17	26	25

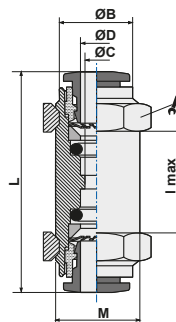

ART. T10L

Passaparete a "L"
L bulkhead

CODICE	ØD	M	B	E	H	L max	CH	
T10L0400	4	12x1	28,5	19,0	14	6	14	25
T10L0600	6	14x1	32,1	19,2	17	7	17	25
T10L0800	8	16x1	39,4	23,0	19	7,5	19	25
T10L1000	10	20x1	44,8	28,2	24	9,5	24	25
T10L1200	12	22x1	46,6	29,5	27	10	26	10

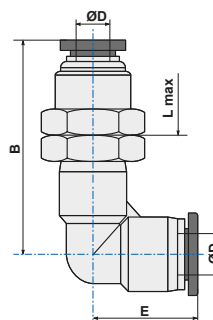

NOTA: articolo di importazione - NOTE: imported item

ART. T11

 Croce intermedio
Cross connector

CODICE	ØD		ØB	ØA	C		
T110400	4		9,5	17,2	3		25
T110600	6		11,5	20,8	3		25
T110800	8		13,5	23,0	3		25
T111000*	10		17,0	6,5	3		10
T111200*	12		20,0	28,8	3		10

* = di importazione - imported

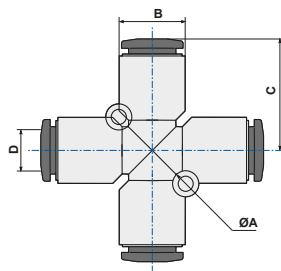
ART. T13

 Anello semplice
Single banjo body

CODICE	ØD	G*	ØC	ØB	ØA	H	L	ØF	
T1304M5	4	M5	3	9,5	5	10	19,5	8,0	50
T130418	4	1/8	3	9,5	9,9	15	21,1	14,0	50
T130618	6	1/8	5	11,5	9,9	15	24,3	14,0	50
T130614	6	1/4	5	11,5	13,3	17	25,5	18,0	50
T130818	8	1/8	7	13,5	9,9	15	24,8	14,0	50
T130814	8	1/4	7	13,5	13,3	17	26,5	18,0	50
T130838	8	3/8	7	13,5	16,75	20	28,0	21,3	50
T131014	10	1/4	9	17,0	13,3	17	28,4	18,0	50
T131038	10	3/8	9	17,0	16,75	20	29,9	21,3	25
T131012	10	1/2	9	17,0	13,3	24	30,0	26,0	25
T131238	12	3/8	10	20,0	16,75	20	31,4	21,3	25
T131212	12	1/2	10	20,0	21	24	34,9	26,0	25
T13R04M5	4	M5	3	9,5	6	10	19,5	8	50
T13R06M5	6	M5	5	11,5	6	10	23	8	50

(*) G = filetto vite/asta

(*) G = steam thread

Vedi capitolo Astine pag. 39

See page 39 of Stems section

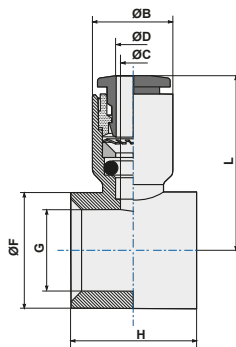
ART. T13B

 Anello semplice due vie
Single branch body

CODICE	ØD	G*		H	L	L2	
T13B04M5	4	M5		10	19,5	19	50
T13B0618	6	1/8		15	24,3	23	50
T13B0814	8	1/4		17	26,5	27	50
T13B1038	10	3/8		20	29,9	34	25
T13B1212	12	1/2		24	34,9	40	10

(*) G = filetto vite/asta

(*) G = steam thread

H = altezza sede asta - H = stem site length

Vedi capitolo Astine pag. 39

See page 39 of Stems section

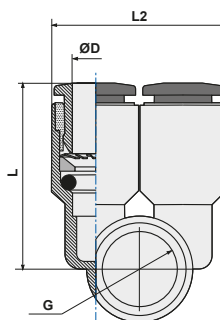

ART. T14

Anello doppio
Double banjo body

CODICE	ØD	G*	ØC	ØB	H	ØF	L	
T1404M5	4	M5	3	9,5	10	8,0	19,5	50
T140418	4	1/8	3	9,5	15	14,0	21,1	50
T140814	8	1/4	7	13,5	17	18,0	26,5	50
T140838	8	3/8	7	13,5	20	21,3	28,0	25
T141014	10	1/4	9	17,0	17	18,0	28,4	50
T141038	10	3/8	9	17,0	20	21,3	29,9	25
T141012	10	1/2	9	17,0	24	26,0	30,0	10
T141238	12	3/8	10	20,0	20	21,3	31,4	25
T141212	12	1/2	10	20,0	24	26,0	34,9	10

(*) G = filetto vite/asta
(*) G = steam thread

Vedi capitolo Astine pag. 39
See page 39 of Stems section

Art. disponibile fino ad esaurimento scorte
Item available while stocks last

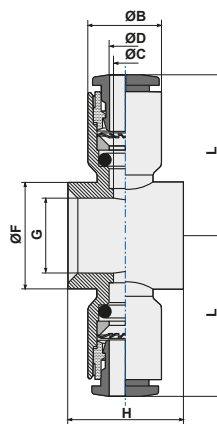

ART. T15

Anello semplice girevole con asta
Complete single banjo (rotating under pressure)

CODICE	ØD	G	ØA	H	L1	L	⊙	
T1504M5	4	M5	2,0	4,0	17,8	19,5	2,5	50
T1504M6	4	M6	2,0	5,0	18,9	19,5	2,5	50
T150418	4	1/8	5,5	5,5	24,5	21,1	3,0	50
T150618	6	1/8	5,5	5,5	24,5	24,3	3,0	50
T150614	6	1/4	7,8	6,5	28,0	25,5	4,0	50
T150818	8	1/8	5,5	5,5	24,5	24,8	3,0	50
T150814	8	1/4	7,8	6,5	28,0	26,5	4,0	50
T150838	8	3/8	10,0	7,5	32,5	28,0	5,0	25
T151014	10	1/4	7,8	6,5	28,0	28,4	4,0	25
T151038	10	3/8	10,0	7,5	32,5	29,9	5,0	25
T151012	10	1/2	12,0	9,0	38,8	30,0	8,0	10
T151238	12	3/8	10,0	7,5	32,5	31,4	5,0	10
T151212	12	1/2	12,0	9,0	38,8	34,9	8,0	10

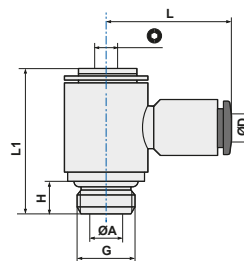

ART. T15C

Anello semplice girevole con asta conico
Complete single banjo tapered

CODICE	ØD	G	A	L	ØK	E		
T15C0418	4	1/8	7,5	23,0	14,4	23,5	12	50
T15C0618	6	1/8	7,5	23,0	14,4	24,0	12	50
T15C0614	6	1/4	9,5	26,5	18,3	25,4	14	50
T15C0638	6	3/8	10,5	32,0	22,0	29,5	19	25
T15C0818	8	1/8	7,5	23,0	14,4	28,9	14	50
T15C0814	8	1/4	9,5	26,5	18,3	29,1	14	50
T15C0838	8	3/8	10,5	32,0	22,0	30,0	19	25
T15C1014	10	1/4	9,5	26,5	18,3	33,0	14	25
T15C1038	10	3/8	10,5	32,0	22,0	33,5	19	25
T15C1012	10	1/2	13,5	38,5	28,0	36,5	24	10
T15C1238	12	3/8	10,5	32,0	22,0	35,8	19	10
T15C1212	12	1/2	13,5	38,5	28,0	36,8	24	10

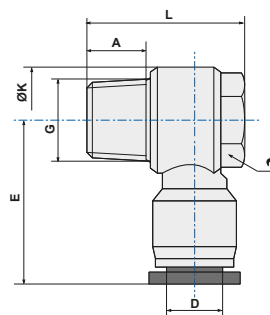

NOTA: articolo di importazione - NOTE: imported item

ART. T15FC

 Anello semplice girevole con asta femmina conico
Female complete single banjo tapered

CODICE	ØD	G/G1	L1	A1	B	ØK		
T15FC0418	4	1/8	23,5	7,5	29,0	14,4	14	50
T15FC0414	4	1/4	25,5	9,5	35,0	18,3	17	50
T15FC0618	6	1/8	24,0	7,5	29,0	14,4	14	50
T15FC0614	6	1/4	25,4	9,5	35,0	18,3	17	50
T15FC0818	8	1/8	26,5	7,5	29,0	14,4	14	50
T15FC0814	8	1/4	28,9	9,5	35,0	18,3	17	50
T15FC0838	8	3/8	30,0	10,5	40,0	22,0	21	25
T15FC1014	10	1/4	33,0	9,5	35,0	22,0	21	25
T15FC1038	10	3/8	33,5	10,5	40,0	28,0	24	25
T15FC1012	10	1/2	36,5	13,5	47,5	18,3	17	10
T15FC1238	12	3/8	35,5	10,5	40,0	22,0	21	10
T15FC1212	12	1/2	36,5	13,5	47,5	28,0	24	10

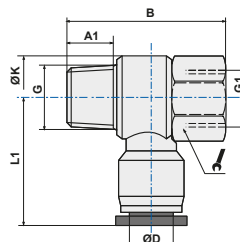
 NOTA: articolo di importazione
 NOTE: imported item

ART. T15B

 Anello due vie girevole con asta
Single branch universal male elbow

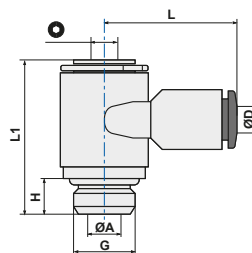
CODICE	ØD	G	ØA	H	L1	L		
T15B04M5	4	M5	2,0	4,0	17,8	19,5	2,5	50
T15B0618	6	1/8	5,5	5,5	24,5	24,3	3,0	50
T15B0814	8	1/4	7,8	6,5	28,0	26,5	4,0	50
T15B1038	10	3/8	10,0	7,5	32,5	29,9	5,0	25
T15B1212	12	1/2	12,0	9,0	38,8	34,9	8,0	10

ART. T16

 Anello doppio girevole con asta
Complete double banjo (rotating under pressure)

CODICE	ØD	G	ØA	H	L1	L		
T1604M5	4	M5	2,0	4,0	17,8	19,5	2,5	50
T160418	4	1/8	5,5	5,5	24,5	21,1	3,0	50
T160814	8	1/4	7,8	6,5	28,0	26,5	4,0	25
T160838	8	3/8	10,0	7,5	32,5	28,0	5,0	25
T161014	10	1/4	7,8	6,5	28,0	28,4	4,0	25
T161038	10	3/8	10,0	7,5	32,5	29,9	5,0	25
T161012	10	1/2	12,0	9,0	38,8	30,0	8,0	10
T161238	12	3/8	10,0	7,5	32,5	31,4	5,0	25
T161212	12	1/2	12,0	9,0	38,8	34,9	8,0	10

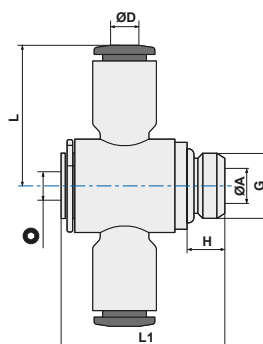

 Art. disponibile fino ad esaurimento scorte
 Item available while stocks last

ART. T18

Giunzione tripla intermedia
Triple branch union

CODICE	ØD	ØD1	J	B	Ød	F2		
T180604	6	4	22	58,0	3,2	36	25	
T180804	8	4	26	63,4	3,2	42	25	
T180806	8	6	26	63,4	3,2	42	25	
T181006	10	6	29	83,8	4,2	48	10	
T181008	10	8	29	83,6	4,2	48	10	

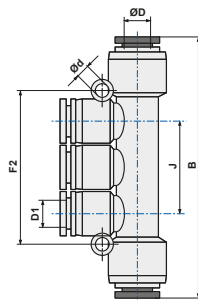
NOTA: articolo di importazione - NOTE: imported item



ART. T18G

Giunzione tripla filettata
Male triple branch

CODICE	ØD	D1	G	A	B	J		Ød	
T18G0418	4	4	1/8	5,5	68,0	26	14	3,2	25
T18G0414	4	4	1/4	7,5	70,0	26	17	3,2	25
T18G0438	4	4	3/8	7,5	70,0	26	20	3,2	10
T18G0618	6	6	1/8	5,5	68,0	26	14	3,2	25
T18G0614	6	6	1/4	7,5	70,0	26	17	3,2	25
T18G0638	6	6	3/8	7,5	70,5	26	20	3,2	10
T18G0612	6	6	1/2	9	73,0	26	24	3,2	10
T18G0818	8	8	1/8	5,5	87,0	29	14	3,2	10
T18G0814	8	8	1/4	7,5	89,0	29	17	3,2	10
T18G0838	8	8	3/8	7,5	89,5	29	20	3,2	10
T18G0812	8	8	1/2	9	92,5	29	24	3,2	10
T18G1018	10	10	1/8	5,5	95,5	37	14	4,2	10
T18G1014	10	10	1/4	7,5	98,0	37	17	4,2	10
T18G1038	10	10	3/8	7,5	98,5	37	20	4,2	10
T18G1012	10	10	1/2	9	101,5	37	24	4,2	10

NOTA: articolo di importazione - NOTE: imported item

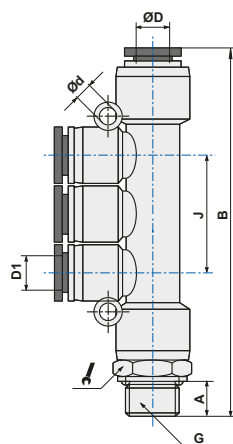

ART. T20

Raccordo a T centrale girevole
Swivel male stud T parallel

CODICE	ØD	G	ØB	H	L	L1		
T2004M3	4	M3	9,5	3,0	17,2	15,0	8	50
T2004M5	4	M5	9,5	4,0	17,2	17,0	8	50
T200418	4	1/8	9,5	5,5	17,2	18,5	13	50
T200414	4	1/4	9,5	7,5	17,2	20,4	16	50
T200438*	4	3/8	11,0	7,5	19,0	27,3	20	25
T2006M5	6	M5	9,5	4,0	20,8	17,0	8	50
T200618	6	1/8	11,5	5,5	20,8	18,5	13	50
T200614	6	1/4	11,5	7,5	20,8	20,4	16	50
T200638*	6	3/8	13,0	7,5	19,5	27,5	20	25
T200612*	6	1/2	13,0	9	19,5	30,0	24	10
T200818	8	1/8	13,5	5,5	23,0	20,0	13	50
T200814	8	1/4	13,5	6,5	23,0	20,4	16	50
T200838	8	3/8	13,5	7,5	23,0	24,8	18	25
T200812*	8	1/2	15,0	9	22,5	32,5	24	10
T201018*	10	1/8	19,0	5,5	28,5	32,3	17	25
T201014	10	1/4	17,0	7,5	26,4	23,2	16	25
T201038*	10	3/8	19,0	10,5	28,5	38,0	17	25
T201012*	10	1/2	17,0	9	26,4	31,1	21	10
T201218*	12	1/8	21,5	5,5	29,5	33,5	27	10
T201214*	12	1/4	21,5	7,5	29,5	38,5	21	10
T201238*	12	3/8	20,0	7,5	28,9	26,3	18	10
T201212*	12	20	20,0	9	28,9	29,3	21	10

* = di importazione - imported

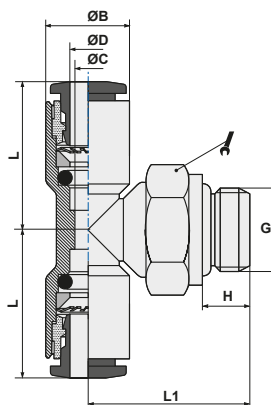

ART. T21

 Raccordo a T laterale girevole
Swivel male branch T parallel

CODICE	ØD	G	ØB	H	L	L1		
T2104M3	4	M3	9,5	3	12,2	15,0	8	50
T2104M5	4	M5	9,5	4	12,2	17,0	8	50
T210418	4	1/8	9,5	5,5	17,2	18,5	13	50
T210414	4	1/4	9,5	7,5	17,2	20,4	16	50
T210438*	4	3/8	11,0	7,5	19	27,3	20	25
T210618	6	1/8	11,5	5,5	20,8	18,5	13	50
T210614	6	1/4	11,5	7,5	20,8	20,4	16	50
T210638*	6	3/8	13,0	7,5	19,7	27,5	20	25
T210612*	6	1/2	13,0	9	19,7	30	24	10
T210818	8	1/8	13,5	5,5	23	20	13	50
T210814	8	1/4	13,5	7,5	23	20,4	16	50
T210838	8	3/8	13,5	9	23	24,8	18	25
T210812*	8	1/2	14,4	9	22,5	32,5	24	10
T211018*	10	1/8	19,0	5,5	27,8	32,5	17	25
T211014*	10	1/4	17,0	6,5	26,4	23,2	16	25
T211038*	10	3/8	19,0	7,5	28,5	38,5	17	25
T211012*	10	1/2	17,0	9	26,4	31,1	21	10
T211218*	12	1/8	21,0	5,5	29,5	33,5	21	25
T211214*	12	1/4	21,0	7,5	29,5	36	21	10
T211238*	12	3/8	20,0	7,5	28,9	26,3	18	10
T211212*	12	1/2	20,0	9	28,9	31,1	21	10

* = di importazione - imported

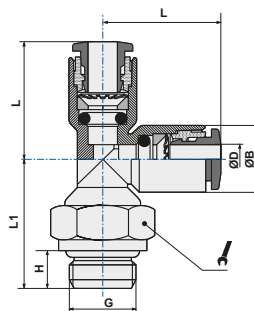
ART. T22

 Gomito girevole filetto cilindrico maschio con O-Ring
Swivel L male adaptor parallel

CODICE	ØD	G	ØB	H	L	L1		
T2204M3	4	M3	9,5	3	17,2	17	8	50
T2204M5	4	M5	9,5	4	17,2	17	8	100
T220418	4	1/8	9,5	5,5	17,2	18,5	13	100
T220414	4	1/4	9,5	6,5	17,2	20,4	16	100
T2206M5	6	M5	11,5	4	20,8	17	8	100
T220618	6	1/8	11,5	5,5	20,8	18,5	13	100
T220614	6	1/4	11,5	6,5	20,8	20,4	16	100
T220818	8	1/8	13,5	5,5	23	20	13	100
T220814	8	1/4	13,5	6,5	23	20,4	16	100
T220838	8	3/8	13,5	7,5	23	24,8	18	50
T221018*	10	1/8	19	5,5	27,8	26	14	50
T221014	10	1/4	17	6,5	26,4	23,2	16	50
T221038	10	3/8	17	7,5	26,4	24,8	18	50
T221012	10	1/2	17	9	26,4	31,1	21	25
T221214	12	1/4	20	6,5	28,9	24,2	16	25
T221238	12	3/8	20	7,5	28,9	26,3	18	25
T221212	12	1/2	20	9	28,9	31,1	21	25

* = di importazione - imported

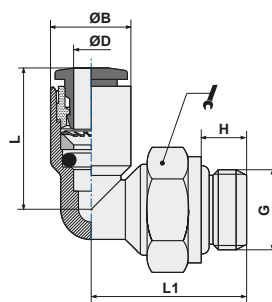

ART. T22C

Gomito girevole filetto conico
Swivel L male adaptor tapered

CODICE	ØD	G	ØB	H	L	L1		
T22C0418	4	1/8	11,5	7,5	17,2	20,5	13	100
T22C0414	4	1/4	11,5	9,5	19,0	20,0	14	100
T22C0438	4	3/8	11,5	10,5	19,0	21,0	17	25
T22C0618	6	1/8	13,5	7,5	19,2	21,5	13	100
T22C0614	6	1/4	13,5	9,5	19,2	21,0	14	100
T22C0638	6	3/8	13,5	10,5	19,2	22,0	17	25
T22C0612	6	1/2	13,5	13,5	19,2	25,5	21	10
T22C0818	8	1/8	15,0	7,5	22,5	22,2	13	100
T22C0814	8	1/4	15,0	9,5	22,5	21,7	14	100
T22C0838	8	3/8	15,0	10,5	23,0	22,7	17	50
T22C0812	8	1/2	15,0	13,5	22,5	26,2	21	10
T22C1018	10	1/8	19,0	7,5	27,8	26,9	13	50
T22C1014	10	1/4	19,0	9,5	27,8	28,4	14	50
T22C1038	10	3/8	19,0	10,5	27,8	24,7	17	50
T22C1012	10	1/2	19,0	13,5	27,8	28,2	21	25
T22C1218	12	1/8	21,5	7,5	29,5	28,2	15	25
T22C1214	12	1/4	21,5	9,5	29,5	29,7	15	25
T22C1238	12	3/8	21,5	10,5	29,5	26,0	21	50
T22C1212	12	1/2	21,5	13,5	29,5	29,5	21	25

NOTA: articolo di importazione - NOTE: imported item

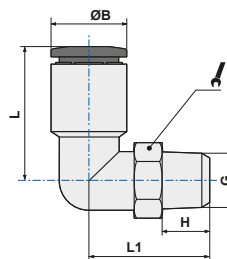

ART. T22F

Gomito girevole femmina
Female swivel L adaptor

CODICE	ØD	G	A	B	E		
T22F04M5	4	M5	5,5	20,5	19,0	10	50
T22F0418	4	1/8	8,5	24,0	19,0	14	50
T22F0414	4	1/4	11,0	27,0	19,0	17	50
T22F06M5	6	M5	6,0	20,7	19,2	12	50
T22F0618	6	1/8	8,5	24,2	19,2	14	50
T22F0614	6	1/4	11,0	27,2	19,2	17	50
T22F0638	6	3/8	12,0	28,7	19,2	21	25
T22F0818	8	1/8	8,0	27,0	23,0	14	50
T22F0814	8	1/4	11,0	30,5	23,0	17	50
T22F0838	8	3/8	12,0	32,0	23,0	21	25
T22F1014	10	1/4	11,0	34,3	28,2	17	25
T22F1038	10	3/8	12,0	35,8	28,2	21	25
T22F1012	10	1/2	14,0	38,8	28,2	24	10
T22F1214	12	1/4	11,0	37,0	29,5	21	25
T22F1238	12	3/8	12,0	38,0	29,5	21	25
T22F1212	12	1/2	14,0	40,5	29,5	24	10

NOTA: articolo di importazione - NOTE: imported item

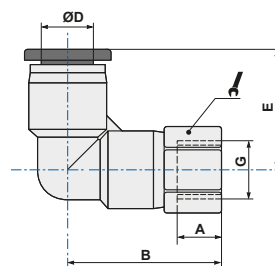

ART. T22L

 Gomito girevole cilindrico lungo
Swivel longer L male adaptor parallel

CODICE	ØD	G	ØB	H	L	L1		
T22L04M5*	4	M5	11,0	3,5	34,5	19,0	10	25
T22L0418	4	1/8	9,5	6,0	35,7	17,2	13	25
T22L06M5*	6	M5	13,0	3,5	36,4	19,2	12	25
T22L0618	6	1/8	11,5	6,0	35,7	20,8	13	25
T22L0818	8	1/8	13,5	6,0	38,0	23,0	13	25
T22L0814*	8	1/4	15,0	7,5	44,3	22,5	17	25

* = di importazione - imported

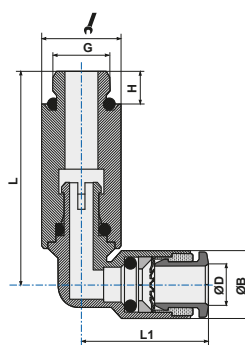
ART. T22LC

 Gomito girevole conico lungo
Swivel longer L male adaptor tapered

CODICE	ØD	G	A	B	ØC	E		
T22LC0418	4	1/8	7,5	37,0	11,0	19,0	10	25
T22LC0414	4	1/4	9,5	40,0	11,0	19,0	14	25
T22LC0618	6	1/8	7,5	39,7	13,0	19,2	12	25
T22LC0614	6	1/4	9,5	42,2	13,0	19,2	14	25
T22LC0638	6	3/8	10,5	43,7	13,0	19,2	17	25
T22LC0818	8	1/8	7,5	44,8	14,4	23,0	14	25
T22LC0814	8	1/4	9,5	46,8	14,4	23,0	17	25
T22LC0838	8	3/8	10,5	48,5	14,4	23,0	17	25
T22LC1018	10	1/8	7,5	54,3	18,5	28,2	17	25
T22LC1014	10	1/4	9,5	56,3	18,5	28,2	17	25
T22LC1038	10	3/8	10,5	57,3	18,5	28,2	17	25
T22LC1012	10	1/2	13,5	60,8	18,5	28,2	21	10
T22LC1214	12	1/4	9,5	61,5	21,0	29,5	21	10
T22LC1238	12	3/8	10,5	62,5	21,0	29,5	21	10
T22LC1212	12	1/2	13,5	65,5	21,0	29,5	21	10

NOTA: articolo di importazione - NOTE: imported item

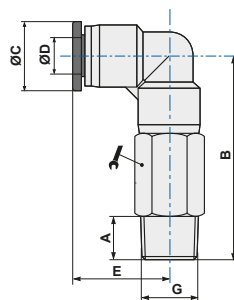
ART. T45

 Gomito girevole cilindrico a 45°
Swivel 45° L male adaptor parallel

CODICE	ØD	G	L1	L2	L3	L4	ØD1		
T4504M5	4	M5	3,5	22,5	19	39,5	11,3	10	1
T450418	4	G1/8	5,5	25,5	19	42,5	11,3	14	1
T450618	6	G1/8	5,5	25,5	19,2	43,5	13,3	14	1
T450614	6	G1/4	7,5	28	19,2	46	13,3	17	1
T450818	8	G1/8	5,5	29	22,5	49,5	14,8	14	1
T450814	8	G1/4	7,5	31,5	22,5	52	14,8	17	1
T451014	10	G1/4	7,5	36	27,8	62,5	18,7	17	1
T451038	10	G3/8	7,5	36	27,8	62,5	18,7	20	1

NOTA: articolo di importazione - NOTE: imported item

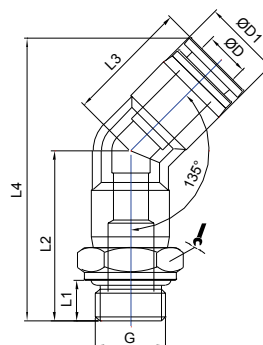

ART. T23

Y innestabile
Y connector

CODICE	ØD1	ØD2	ØE	ØB	A	L		
T230400	4	4	2,40	9,5	19	33,0		50
T230406	4	6	2,40	11,5	19	35,8		50
T230600	6	6	2,60	11,5	23	38,6		50
T230608	6	8	3,20	13,5	23	39,8		50
T230800	8	8	2,75	16,5	27	42,5		50
T230810	8	10	3,20	17,0	27	44,4		25
T231000	10	10	4,30	20,0	34	50,8		25
T231012*	10	12	4,30	20,0	34	50,8		10
T231200	12	12	4,20	20,0	40	53,2		10

* = di importazione - imported

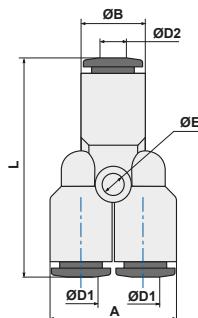

ART. T23L0

Y innestabile
Y connector

CODICE	ØD1	ØD2	ØB	A	ØE	L	L1	
T2304L0	4	4	9,5	19	2,40	50,0	16,7	50
T2306L0	6	6	11,5	23	2,60	58,1	19,5	50
T2308L0	8	8	13,5	27	2,75	63,5	21,0	50
T2310L0	10	10	17,0	34	4,30	74,8	24,0	25
T2312L0	12	12	20,0	40	4,20	78,2	25,0	10

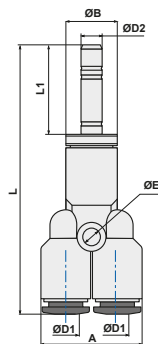

ART. T23G

Y innestabile filetto cilindrico con O-Ring
Y connector with swivel parallel male adapter

CODICE	ØD	G	ØA	ØB	H	A	L		
T23G04M5*	4	M5	2,0	9,5	4,0	19,0	39,1	10	50
T23G0418	4	1/8	3,0	9,5	5,5	19,0	20,5	13	50
T23G0414	4	1/4	3,0	11,0	7,5	22,0	45,5	17	50
T23G0438*	4	3/8	3,0	11,0	7,5	22,0	46,0	20	25
T23G0618	6	1/8	5,0	11,5	5,5	23,0	34,8	13	50
T23G0614	6	1/4	5,0	11,5	6,5	23,0	36,4	16	50
T23G0638*	6	3/8	5,0	13,0	7,5	26,0	47,2	20	25
T23G0818	8	1/8	7,0	13,5	5,5	27,0	37,5	13	50
T23G0814	8	1/4	7,0	13,5	6,5	27,0	38,6	16	50
T23G0838*	8	3/8	6,2	14,4	7,5	29,4	50,5	20	25
T23G1014*	10	1/4	8,2	18,4	7,5	36,4	58,9	17	25
T23G1038*	10	3/8	8,2	18,4	7,5	36,4	58,9	20	25
T23G1012*	10	1/2	8,2	18,4	10	36,4	62,4	24	10
T23G1214*	12	1/4	9,5	21,0	7,5	42,0	62,3	21	10
T23G1238*	12	3/8	9,5	21,0	7,5	42,0	62,3	21	10
T23G1212*	12	1/2	9,5	21,0	10	42,0	65,3	24	10

* = di importazione - imported

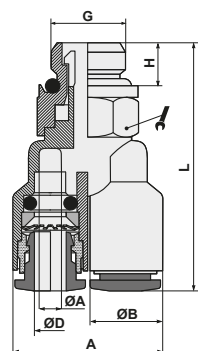

ART. T24

 Y doppio innestabile
Double Y connector

CODICE	ØD1	ØD2	ØE	ØB	A max	L		
T240400	4	4	3,2	9,5	20,2	34,5		25
T240406	4	6	3,2	13,0	20,8	35,5		25
T240408*	4	8	3,2	14,5	22,2	38,5		25
T240600	6	6	3,2	11,5	23,9	39,6		25
T240608*	6	8	3,2	13,5	26,15	41,8		25
T240800*	8	8	3,5	15,0	28,0	42,0		25
T240810	8	10	3,2	17,0	28,0	46,5		25

* = di importazione - imported

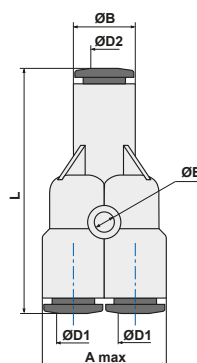
ART. T24LO

 Y doppio innestabile
Double Y connector

CODICE	ØD1	ØD2	ØE	ØB	A	L	L1	
T2404LO	4	4	2,40	9,5	19	51,2	16,7	25
T2406LO	6	6	2,60	11,5	23	59,1	19,5	25
T2408LO	8	8	2,75	13,5	27	67,5	21,0	25

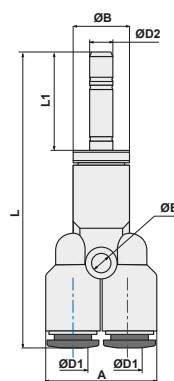
ART. T33

 Doppio anello semplice girevole con asta
Swivel double banjo stem

CODICE	ØD	G	ØA	H	L1	L	⊙	⚙	▮
T3304M5	4	M5	2,0	4,0	28,0	19,5	2,5	14	25
T330418	4	1/8	5,5	5,5	43,3	21,1	3	14	25
T330618	6	1/8	5,5	5,5	43,3	24,3	3	14	25
T330614	6	1/4	7,8	6,5	50,0	25,5	4	18	25
T330818	8	1/8	5,5	5,5	43,3	24,8	3	14	25
T330814	8	1/4	7,8	6,5	50,0	26,5	4	18	25
T331014	10	1/4	7,8	6,5	50,0	28,4	4	18	25

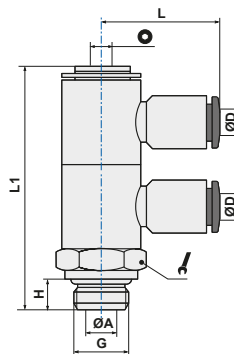
ART. T33B

 Doppio anello due vie girevole con asta
Double branch universal male L

CODICE	ØD	G	ØA	H	L1	L	⊙	⚙	▮
T33B04M5	4	M5	2,0	4,0	28,0	19,5	2,5	14	10
T33B0618	6	1/8	5,5	5,5	43,3	24,3	3	14	10
T33B0814	8	1/4	7,8	6,5	50,0	26,5	4	18	10

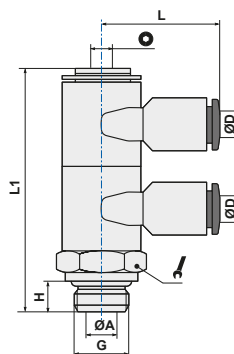

ART. T34

Triplo anello semplice girevole con asta
Swivel triple banjo stem

CODICE	ØD	G	ØA	H	L1	L	⊙	🔧	📏
T340418	4	1/8	5,5	5,5	58,4	21,1	3	14	10
T340618	6	1/8	5,5	5,5	58,4	24,3	3	14	10
T340818	8	1/8	5,5	5,5	58,4	24,8	3	14	10
T340614	6	1/4	7,8	6,5	67	25,5	4	18	10
T340814	8	1/4	7,8	6,5	67	26,5	4	18	10
T341014	10	1/4	7,8	6,5	67	28,4	4	18	10

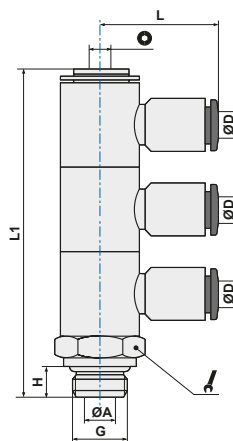

ART. T34B

Triplo anello due vie girevole con asta
Triple branch universal male L

CODICE	ØD	G	ØA	H	L1	L	⊙	🔧	📏
T34B0618	6	1/8	5,5	5,5	58,4	24,3	3	14	10
T34B0814	8	1/4	7,8	6,5	67	26,5	4	18	10

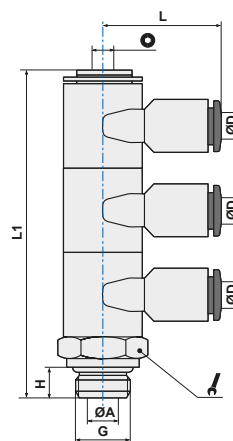

ART. T90

Tappo femmina
Tube Blanking Cap

CODICE	ØD	ØD1	L				📏
T900400	4	11,5	17,5				100
T900600	6	13,5	17,7				100
T900800	8	15	21,3				100
T901000	10	19	25				50
T901200	12	21,5	26				50

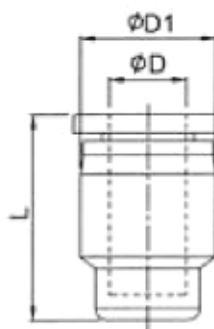

Adattabile a tutti i raccordi della serie Tecno-RAP
Suitable for all Tecno-RAP fitting series

Di importazione
Import

1 ANELLO DI SOSTEGNO
LOCK RING

2 PINZA DI AGGRAFFAGGIO
CRIMPING GRIPPER

3 DISTANZIALE DI FERMO
LOCK RING

4 ANELLO SPINGITORE
THRUST SLEEVE

5 O-RING DI TENUTA
O-RING SEAL

6 BASE GIREVOLE
SWIVEL BASE

7 CORPO DEL RACCORDO
FITTING BODY

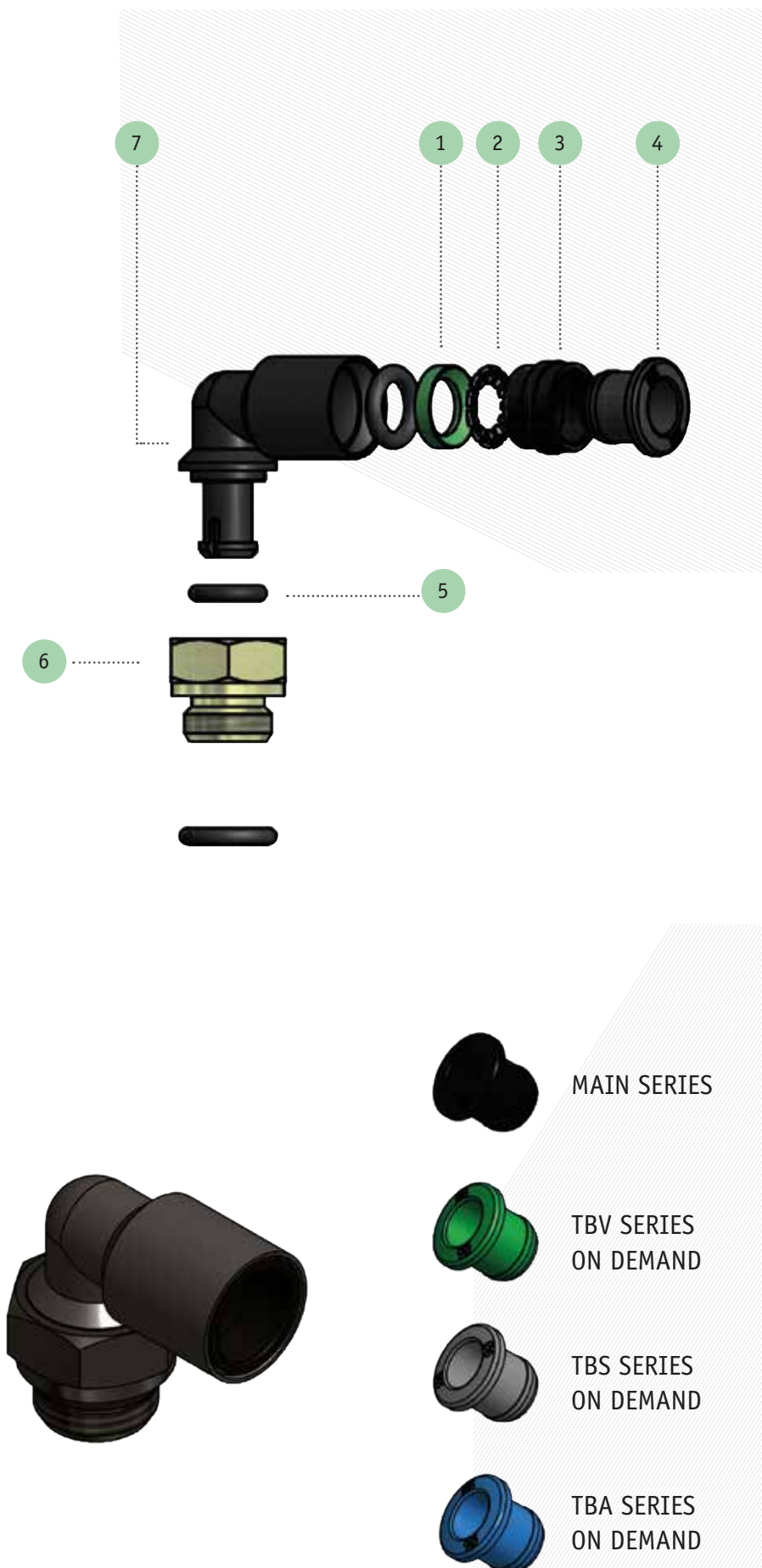

ART. TB01

Diritto filetto cilindrico maschio con O-Ring
Straight male adaptor (parallel)

CODICE	ØD	G	ØC	ØB	H	L			
TB010418	4	1/8	2,5	14,0	5,5	19,0	10	2,5	50
TB010414	4	1/4	2,5	17,5	6,5	20,8	10	2,5	50
TB010618	6	1/8	4,0	14,0	5,5	24,5	12	4,0	50
TB010614	6	1/4	4,0	17,5	6,5	26,0	12	4,0	50
TB010818	8	1/8	5,0	14,0	5,5	25,7	14	5,0	50
TB010814	8	1/4	6,0	17,5	6,5	27,2	14	6,0	50
TB011014	10	1/4	7,0	17,5	6,5	28,7	18	7,0	50

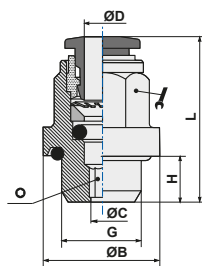

ART. TB03

Diritto innestabile
Straight connector

CODICE	ØD	ØD1	ØC	ØB	ØB1	L	
TB030400	4	4	3	9,5	9,5	32,0	50
TB030406	4	6	3	9,5	11,5	32,5	50
TB030600	6	6	5	11,5	11,5	35,6	50
TB030608	6	8	5	11,5	13,5	36,0	50
TB030800	8	8	7	13,5	13,5	38,0	25
TB030810	8	10	7	13,5	17,0	32,5	50
TB031000	10	10	9	17,0	17,0	42,3	50
TB031012	10	12	9	17,0	20,0	44,0	50
TB031200	12	12	10	20,0	20,0	46,2	25

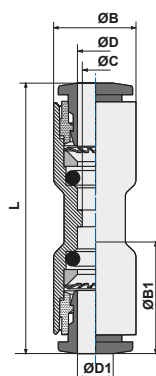

ART. TB04

Gomito innestabile
Elbow connector

CODICE	ØD	ØC	ØB	L	ØE	
TB040400	4	3	9,5	17,2	3,2	50
TB040600	6	5	11,5	20,8	3,2	50
TB040800	8	7	13,5	23,0	3,2	50
TB041000	10	9	17,0	26,4	4,3	50
TB041200	12	10	20,0	28,9	4,2	25

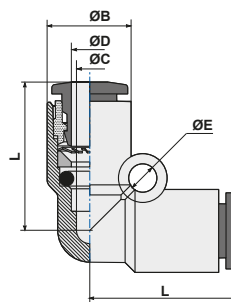

ART. TB04LO

Gomito innestabile con codolo
Plug-in elbow connector

CODICE	ØD	ØC	ØB	L	L1	ØA	L2	
TB0404L0	4	3	9,5	17,2	20,75	4	16,7	50
TB0406L0	6	5	11,5	20,8	24,25	6	19,5	50
TB0408L0	8	7	13,5	23,0	27,25	8	21,0	50
TB0410L0	10	9	17,0	26,4	31,80	10	24,0	50
TB0412L0	12	10	20,0	28,9	36,00	12	25,0	25

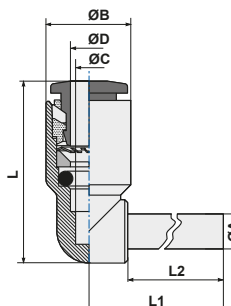

ART. TB05

 T innestabile
T connector

CODICE	ØD	ØD1	ØC	ØB	L		
TB050400	4	4	3,0	9,5	17,2		50
TB050604*	6	4	5,3	13,0	19,2		50
TB050600	6	6	5,0	11,5	20,8		50
TB050806*	8	6	7,1	14,4	22,7		25
TB050800	8	8	7,0	13,5	23,0		50
TB051008*	10	8	9,3	18,4	27,9		25
TB051000	10	10	9,0	17,0	26,4		25
TB051210*	12	10	10,0	21,0	29,9		10
TB051200	12	12	10,0	20,0	28,9		10

* = di importazione - imported

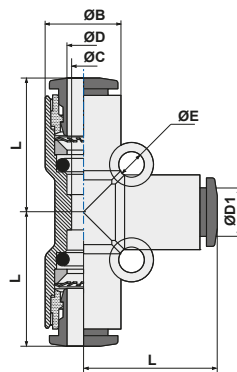
ART. TB05L0

 T Innestabile con codolo centrale
Plug-in T connector (center)

CODICE	ØD	ØC	ØB	L	L1	ØA	L2	
TB0504L0	4	3	9,5	17,2	20,75	4	16,7	50
TB0506L0	6	5	11,5	20,8	24,25	6	19,5	50
TB0508L0	8	7	13,5	23,0	27,25	8	21,0	50
TB0510L0	10	9	17,0	26,4	31,80	10	24,0	25
TB0512L0	12	10	20,0	28,9	36,00	12	25,0	10

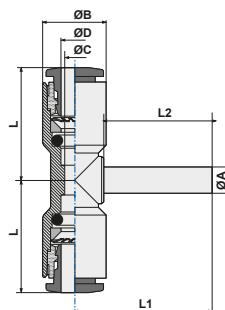
 Art. disponibile fino ad esaurimento scorte
 Item available while stocks last

ART. TB05V0

 T Innestabile con codolo laterale
Plug-in T connector (lateral)

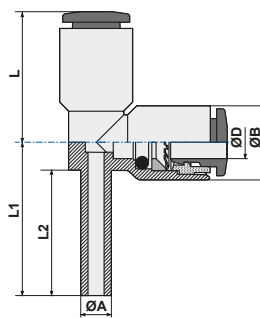
CODICE	ØD	ØB	L	L1	ØA	L2	
TB0506V0	6	11,5	20,8	24,25	6	19,5	50
TB0508V0	8	13,5	23,0	27,25	8	21,0	50
TB0510V0	10	17,0	26,4	31,80	10	24,0	25
TB0512V0	12	20,0	28,9	36,00	12	25,0	10

 Art. disponibile fino ad esaurimento scorte
 Item available while stocks last

ART. TB08

 Riduzione
Reducer

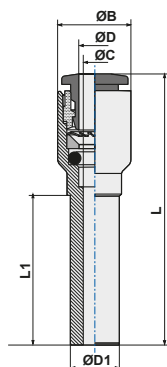
CODICE	ØD1	ØD	ØC	ØB	L	L1	
TB080604	6	4	3	9,5	35,5	19,5	50
TB080804	8	4	3	9,5	37,0	21,0	50
TB081004	10	4	3	9,5	40,0	24,0	25
TB081204	12	4	3	9,5	41,0	25,0	25
TB080806	8	6	5	11,5	39,05	23,0	50
TB081006	10	6	5	11,5	42,05	24,0	25
TB081206	12	6	5	11,5	43,05	25,0	25
TB081008	10	8	7	13,5	43,0	26,25	25
TB081208	12	8	7	13,5	44,0	25,0	25
TB081210	12	10	9	17,0	46,15	27,55	25



ART. TB10

Passaparete
Bulkhead connector

CODICE	ØD	ØB	L	M	Imax		
TB100400	4	9,5	32,0	11x1	8	14	50
TB100600	6	11,5	36,1	14x1	8	17	50
TB100800	8	13,5	38,0	16x1	10	18	50
TB101000	10	17,5	42,3	20x1	12	24	25
TB101200	12	20,0	46,2	22x1	17	26	25

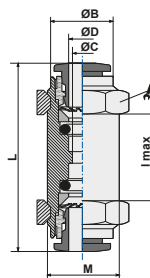

ART. TB10L

Passaparete a "L"
L bulkhead

CODICE	ØD	M	B	E	H	L max	
TB10L0400	4	12x1	28,5	19,0	14	6	25
TB10L0600	6	14x1	32,1	19,2	17	7	25
TB10L0800	8	16x1	39,4	23,0	19	7,5	25
TB10L1000	10	20x1	44,8	28,2	24	9,5	25
TB10L1200	12	22x1	46,6	29,5	27	10	50

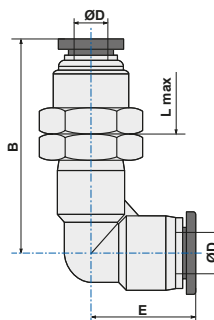

NOTA: articolo di importazione - NOTE: imported item

ART. TB11

Croce intermedio
Cross connector

CODICE	ØD	ØB	ØA	C	
TB110400	4	9,5	17,2	3	25
TB110600	6	11,5	20,8	3	25
TB110800	8	13,5	23,0	3	25
TB111000*	10	17,0	6,5	3	10
TB111200*	12	20,0	28,8	3	10

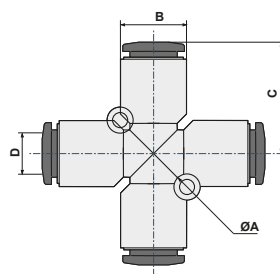

* = di importazione - imported

ART. TB13

Anello semplice
Single banjo body

CODICE	ØD	G*	ØC	ØB	H	L	ØF	
TB1304M5	4	M5	3	9,5	10	19,5	8,0	50
TB130418	4	1/8	3	9,5	15	21,1	14,0	50
TB130618	6	1/8	5	11,5	15	24,3	14,0	50
TB130614	6	1/4	5	11,5	17	25,5	18,0	50
TB130818	8	1/8	7	13,5	15	24,8	14,0	50
TB130814	8	1/4	7	13,5	17	26,5	18,0	50
TB130838	8	3/8	7	13,5	20	28,0	21,3	50
TB131014	10	1/4	9	17,0	17	28,4	18,0	50
TB131038	10	3/8	9	17,0	20	29,9	21,3	25
TB131012	10	1/2	9	17,0	24	30,0	26,0	25
TB131238	12	3/8	10	20,0	20	31,4	21,3	25
TB131212	12	1/2	10	20,0	24	34,9	26,0	25
TB13R04M5	4	M5	3	9,5	10	19,5	8	50
TB13R06M5	6	M5	5	11,5	10	23	8	50

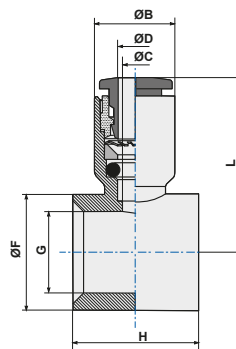

(*) G = filetto vite/asta
(*) G = steam thread

Vedi capitolo Astine pag. 39
See page 39 of Stems section

ART. TB13B

 Anello semplice due vie
Single branch body

CODICE	ØD	G*		H	L	L2		
TB13B04M5	4	M5		10	19,5	19		50
TB13B0618	6	1/8		15	24,3	23		50
TB13B0814	8	1/4		17	26,5	27		50
TB13B1038	10	3/8		20	29,9	34		25
TB13B1212	12	1/2		24	34,9	40		10

(*) G = filetto vite/asta

(*) G = steam thread

H = altezza sede asta - H = stem site lenght

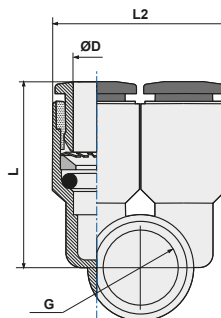
 Vedi capitolo Astine pag. 39
 See page 39 of Stems section

ART. TB14

 Anello doppio
Double banjo body

CODICE	ØD	G*	ØC	ØB	H	ØF	L	
TB1404M5	4	M5	3	9,5	10	8,0	19,5	50
TB140418	4	1/8	3	9,5	15	14,0	21,1	50
TB140618	6	1/8	5	11,5	15	14,0	24,3	50
TB140614	6	1/4	5	11,5	17	18,0	25,5	50
TB140818	8	1/8	7	13,5	15	14,0	24,8	50
TB140814	8	1/4	7	13,5	17	18,0	26,5	50
TB140838	8	3/8	7	13,5	20	21,3	28,0	25
TB141014	10	1/4	9	17,0	17	18,0	28,4	50
TB141038	10	3/8	9	17,0	20	21,3	29,9	25
TB141012	10	1/2	9	17,0	24	26,0	30,0	10
TB141238	12	3/8	10	20,0	20	21,3	31,4	25
TB141212	12	1/2	10	20,0	24	26,0	34,9	10

(*) G = filetto vite/asta

(*) G = steam thread

 Art. disponibile fino ad esaurimento scorte
 Item available while stocks last

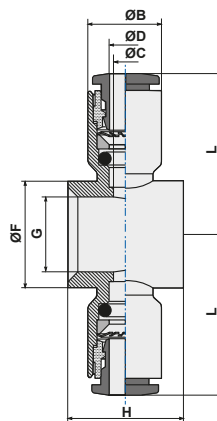
 Vedi capitolo Astine pag. 39
 See page 39 of Stems section

ART. TB15

 Anello semplice girevole con asta
Complete single banjo (rotating under pressure)

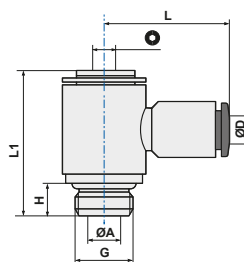
CODICE	ØD	G	ØA	H	L1	L	⊙	
TB1504M5	4	M5	2,0	4,0	17,8	19,5	2,5	50
TB1504M6	4	M6	2,0	5,0	18,9	19,5	2,5	50
TB150418	4	1/8	5,5	5,5	24,5	21,1	3,0	50
TB150618	6	1/8	5,5	5,5	24,5	24,3	3,0	50
TB150614	6	1/4	7,8	6,5	28,0	25,5	4,0	50
TB150818	8	1/8	5,5	5,5	24,5	24,8	3,0	50
TB150814	8	1/4	7,8	6,5	28,0	26,5	4,0	50
TB150838	8	3/8	10,0	7,5	32,5	28,0	5,0	25
TB151014	10	1/4	7,8	6,5	28,0	28,4	4,0	25
TB151038	10	3/8	10,0	7,5	32,5	29,9	5,0	25
TB151012	10	1/2	12,0	9,0	38,8	30,0	8,0	10
TB151238	12	3/8	10,0	7,5	32,5	31,4	5,0	10
TB151212	12	1/2	12,0	9,0	38,8	34,9	8,0	10



ART. TB15C

Anello semplice girevole con asta conico
Complete single banjo tapered

CODICE	ØD	G	A	L	ØK	E		
TB15C0418	4	1/8	7,5	23,0	14,4	23,5	12	50
TB15C0618	6	1/8	7,5	23,0	14,4	24,0	12	50
TB15C0614	6	1/4	9,5	26,5	18,3	25,4	14	50
TB15C0638	6	3/8	10,5	32,0	22,0	29,5	19	25
TB15C0818	8	1/8	7,5	23,0	14,4	28,9	14	50
TB15C0814	8	1/4	9,5	26,5	18,3	29,1	14	50
TB15C0838	8	3/8	10,5	32,0	22,0	30,0	19	25
TB15C1014	10	1/4	9,5	26,5	18,3	33,0	14	25
TB15C1038	10	3/8	10,5	32,0	22,0	33,5	19	25
TB15C1012	10	1/2	13,5	38,5	28,0	36,5	24	10
TB15C1238	12	3/8	10,5	32,0	22,0	35,8	19	10
TB15C1212	12	1/2	13,5	38,5	28,0	36,8	24	10

NOTA: articolo di importazione - NOTE: imported item

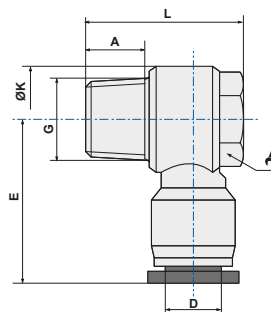

ART. TB15FC

Anello semplice girevole con asta femmina conico
Female complete single banjo tapered

CODICE	ØD	G/G1	L1	A1	B	ØK		
TB15FC0418	4	1/8	23,5	7,5	29,0	14,4	14	50
TB15FC0414	4	1/4	25,5	9,5	35,0	18,3	17	50
TB15FC0618	6	1/8	24,0	7,5	29,0	14,4	14	50
TB15FC0614	6	1/4	25,4	9,5	35,0	18,3	17	50
TB15FC0818	8	1/8	26,5	7,5	29,0	14,4	14	50
TB15FC0814	8	1/4	28,9	9,5	35,0	18,3	17	50
TB15FC0838	8	3/8	30,0	10,5	40,0	22,0	21	25
TB15FC1014	10	1/4	33,0	9,5	35,0	22,0	21	25
TB15FC1038	10	3/8	33,5	10,5	40,0	28,0	24	25
TB15FC1012	10	1/2	36,5	13,5	47,5	18,3	17	10
TB15FC1238	12	3/8	35,5	10,5	40,0	22,0	21	10
TB15FC1212	12	1/2	36,5	13,5	47,5	28,0	24	10

NOTA: articolo di importazione
NOTE: imported item

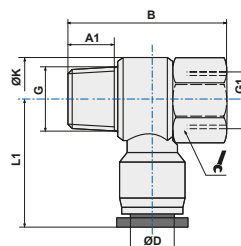

ART. TB15B

Anello due vie girevole con asta
Single branch universal male L

CODICE	ØD	G	ØA	H	L1	L	Ø	
TB15B04M5	4	M5	2,0	4,0	17,8	19,5	2,5	50
TB15B0618	6	1/8	5,5	5,5	24,5	24,3	3,0	50
TB15B0814	8	1/4	7,8	6,5	28,0	26,5	4,0	50
TB15B1038	10	3/8	10,0	7,5	32,5	29,9	5,0	25
TB15B1212	12	1/2	12,0	9,0	38,8	34,9	8,0	10

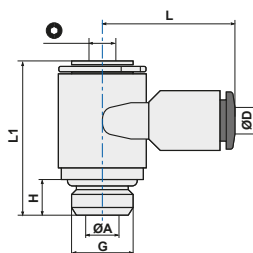

ART. TB16

 Anello doppio girevole con asta
Complete double banjo (rotating under pressure)

CODICE	ØD	G	ØA	H	L1	L	⊙	
TB1604M5	4	M5	2,0	4,0	17,8	19,5	2,5	50
TB160418	4	1/8	5,5	5,5	24,5	21,1	3,0	50
TB160618	6	1/8	5,5	5,5	24,5	24,3	3,0	50
TB160614	6	1/4	7,8	6,5	28,0	25,5	4,0	50
TB160818	8	1/8	5,5	5,5	24,5	24,8	3,0	50
TB160814	8	1/4	7,8	6,5	28,0	26,5	4,0	25
TB160838	8	3/8	10,0	7,5	32,5	28,0	5,0	25
TB161014	10	1/4	7,8	6,5	28,0	28,4	4,0	25
TB161038	10	3/8	10,0	7,5	32,5	29,9	5,0	25
TB161012	10	1/2	12,0	9,0	38,8	30,0	8,0	10
TB161238	12	3/8	10,0	7,5	32,5	31,4	5,0	25
TB161212	12	1/2	12,0	9,0	38,8	34,9	8,0	10

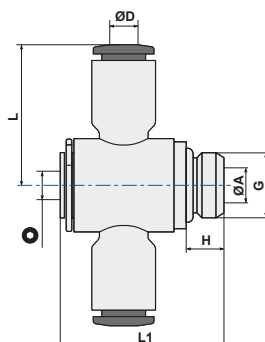
 Art. disponibile fino ad esaurimento scorte
 Item available while stocks last

ART. TB18

 Giunzione tripla intermedia
Triple branch union

CODICE	ØD	ØD1	J	B	Ød	F2	
TB180604	6	4	22	58,0	3,2	36	25
TB180804	8	4	26	63,4	3,2	42	25
TB180806	8	6	26	63,4	3,2	42	25
TB181006	10	6	29	83,8	4,2	48	10
TB181008	10	8	29	83,6	4,2	48	10

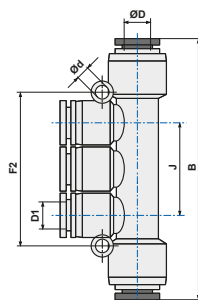
NOTA: articolo di importazione - NOTE: imported item

ART. TB18G

 Giunzione tripla filettata
Male triple branch

CODICE	ØD	D1	G	A	B	J		Ød	
TB18G0418	4	4	1/8	5,5	68,0	26	14	3,2	25
TB18G0414	4	4	1/4	7,5	70,0	26	17	3,2	25
TB18G0438	4	4	3/8	7,5	70,0	26	20	3,2	10
TB18G0618	6	6	1/8	5,5	68,0	26	14	3,2	25
TB18G0614	6	6	1/4	7,5	70,0	26	17	3,2	25
TB18G0638	6	6	3/8	7,5	70,5	26	20	3,2	10
TB18G0612	6	6	1/2	10	73,0	26	24	3,2	10
TB18G0818	8	8	1/8	5,5	87,0	29	14	3,2	10
TB18G0814	8	8	1/4	7,5	89,0	29	17	3,2	10
TB18G0838	8	8	3/8	7,5	89,5	29	20	3,2	10
TB18G0812	8	8	1/2	10	92,5	29	24	3,2	10
TB18G1018	10	10	1/8	5,5	95,5	37	14	4,2	10
TB18G1014	10	10	1/4	7,5	98,0	37	17	4,2	10
TB18G1038	10	10	3/8	7,5	98,5	37	20	4,2	10
TB18G1012	10	10	1/2	10	101,5	37	24	4,2	10

NOTA: articolo di importazione - NOTE: imported item

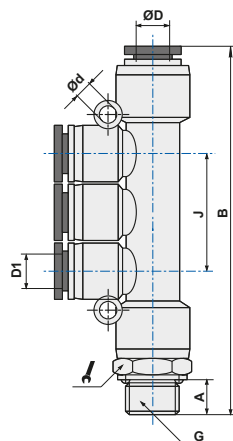

ART. TB20

Raccordo a T laterale girevole
Swivel male stud T parallel

CODICE	ØD	G	ØB	H	L	L1		
TB2004M3	4	M3	9,5	3,0	17,2	15,0	8	50
TB2004M5	4	M5	9,5	4,0	17,2	17,0	8	50
TB200418	4	1/8	9,5	5,5	17,2	18,5	13	50
TB200414	4	1/4	9,5	7,5	17,2	20,4	16	50
TB200438*	4	3/8	11,0	7,5	19,0	27,3	20	25
TB2006M5	6	M5	9,5	4,0	20,8	17,0	8	50
TB200618	6	1/8	11,5	5,5	20,8	18,5	13	50
TB200614	6	1/4	11,5	7,5	20,8	20,4	16	50
TB200638*	6	3/8	13,0	7,5	19,5	27,5	20	25
TB200612*	6	1/2	13,0	10	19,5	30,0	24	10
TB200818	8	1/8	13,5	5,5	23,0	20,0	13	50
TB200814	8	1/4	13,5	6,5	23,0	20,4	16	50
TB200838	8	3/8	13,5	7,5	23,0	24,8	18	25
TB200812*	8	1/2	15,0	10	22,5	32,5	24	10
TB201018*	10	1/8	19,0	5,5	28,5	32,3	17	25
TB201014	10	1/4	17,0	7,5	26,4	23,2	16	25
TB201038*	10	3/8	19,0	10,5	28,5	38,0	17	25
TB201012*	10	1/2	17,0	9	26,4	31,1	21	10
TB201218*	12	1/8	21,5	5,5	29,5	33,5	27	10
TB201214*	12	1/4	21,5	7,5	29,5	38,5	21	10
TB201238*	12	3/8	20,0	7,5	28,9	26,3	18	10
TB201212*	12	20	20,0	11	28,9	29,3	21	10

* = di importazione - imported

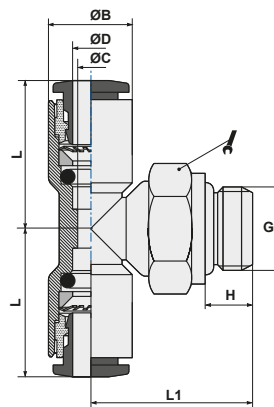

ART. TB21

Raccordo a T laterale girevole
Swivel male branch T parallel

CODICE	ØD	G	ØB	H	L	L1		
TB2104M3	4	M3	9,5	3	12,2	15,0	8	50
TB2104M5	4	M5	9,5	4	12,2	17,0	8	50
TB210418	4	1/8	9,5	5,5	17,2	18,5	13	50
TB210414	4	1/4	9,5	7,5	17,2	20,4	16	50
TB210438*	4	3/8	11,0	7,5	19	27,3	20	25
TB2106M5	6	M5	9,5	4	20,8	17	8	50
TB210618	6	1/8	11,5	5,5	20,8	18,5	13	50
TB210614	6	1/4	11,5	7,5	20,8	20,4	16	50
TB210638*	6	3/8	13,0	7,5	19,7	27,5	20	25
TB210612*	6	1/2	13,0	10	19,7	30	24	10
TB210818	8	1/8	13,5	5,5	23	20	13	50
TB210814	8	1/4	13,5	7,5	23	20,4	16	50
TB210838	8	3/8	13,5	9	23	24,8	18	25
TB210812*	8	1/2	14,4	9	22,5	32,5	24	10
TB211018*	10	1/8	19,0	5,5	27,8	32,5	17	25
TB211014*	10	1/4	17,0	6,5	26,4	23,2	16	25
TB211038*	10	3/8	19,0	7,5	28,5	38,5	17	25
TB211012*	10	1/2	17,0	10	26,4	31,1	21	10
TB211218*	12	1/8	21,0	5,5	29,5	33,5	21	25
TB211214*	12	1/4	21,0	7,5	29,5	36	21	10
TB211238*	12	3/8	20,0	7,5	28,9	26,3	18	10
TB211212*	12	1/2	20,0	9	28,9	31,1	21	10

* = di importazione - imported

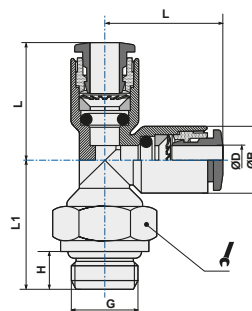

ART. TB22

 Gomito girevole filetto cilindrico maschio con O-Ring
Swivel L male adaptor parallel

CODICE	ØD	G	ØB	H	L	L1		
TB2204M3	4	M3	9,5	4	17,2	17	8	50
TB2204M5	4	M5	9,5	4	17,2	17	8	100
TB220418	4	1/8	9,5	5,5	17,2	18,5	13	100
TB220414	4	1/4	9,5	6,5	17,2	20,4	16	100
TB2206M5	6	M5	11,5	4	20,8	17	8	100
TB220618	6	1/8	11,5	5,5	20,8	18,5	13	100
TB220614	6	1/4	11,5	6,5	20,8	20,4	16	100
TB220818	8	1/8	13,5	5,5	23	20	13	100
TB220814	8	1/4	13,5	6,5	23	20,4	16	100
TB220838	8	3/8	13,5	7,5	23	24,8	18	50
TB221018*	10	1/8	19	5,5	27,8	26	14	50
TB221014	10	1/4	17	6,5	26,4	23,2	16	50
TB221038	10	3/8	17	7,5	26,4	24,8	18	50
TB221012	10	1/2	17	9	26,4	31,1	21	25
TB221214	12	1/4	20	6,5	28,9	24,2	16	50
TB221238	12	3/8	20	7,5	28,9	26,3	18	50
TB221212	12	1/2	20	9	28,9	31,1	21	25

* = di importazione - imported

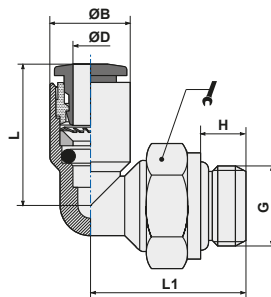
ART. TB22C

 Gomito girevole filetto conico
Swivel L male adaptor tapered

CODICE	ØD	G	ØB	H	L	L1		
TB22C0418	4	1/8	11,5	7,5	17,2	20,5	10	100
TB22C0414	4	1/4	11,5	9,5	19,0	20,0	14	100
TB22C0438	4	3/8	11,5	10,5	19,0	21,0	17	25
TB22C0618	6	1/8	13,5	7,5	19,2	21,5	10	100
TB22C0614	6	1/4	13,5	9,5	19,2	21,0	14	100
TB22C0638	6	3/8	13,5	10,5	19,2	22,0	17	25
TB22C0612	6	1/2	13,5	13,5	19,2	25,5	21	10
TB22C0818	8	1/8	15,0	7,5	22,5	22,2	12	100
TB22C0814	8	1/4	15,0	9,5	22,5	21,7	14	100
TB22C0838	8	3/8	15,0	10,5	23,0	22,7	17	50
TB22C0812	8	1/2	15,0	13,5	22,5	26,2	21	10
TB22C1018	10	1/8	19,0	7,5	27,8	26,9	14	50
TB22C1014	10	1/4	19,0	9,5	27,8	28,4	14	50
TB22C1038	10	3/8	19,0	10,5	27,8	24,7	17	50
TB22C1012	10	1/2	19,0	13,5	27,8	28,2	21	25
TB22C1218	12	1/8	21,5	7,5	29,5	28,2	15	25
TB22C1214	12	1/4	21,5	9,5	29,5	29,7	15	25
TB22C1238	12	3/8	21,5	10,5	29,5	26,0	21	50
TB22C1212	12	1/2	21,5	13,5	29,5	29,5	21	25

NOTA: articolo di importazione - NOTE: imported item

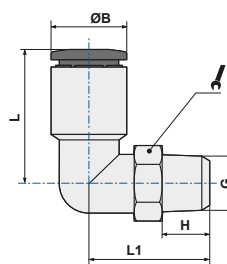

ART. TB22F

Gomito girevole femmina
Female swivel L adaptor

CODICE	ØD	G	A	B	E			
TB22F04M5	4	M5	5,5	20,5	19,0		10	50
TB22F0418	4	1/8	8,5	24,0	19,0		14	50
TB22F0414	4	1/4	11,0	27,0	19,0		17	50
TB22F06M5	6	M5	6,0	20,7	19,2		12	50
TB22F0618	6	1/8	8,5	24,2	19,2		14	50
TB22F0614	6	1/4	11,0	27,2	19,2		17	50
TB22F0638	6	3/8	12,0	28,7	19,2		21	25
TB22F0818	8	1/8	8,0	27,0	23,0		14	50
TB22F0814	8	1/4	11,0	30,5	23,0		17	50
TB22F0838	8	3/8	12,0	32,0	23,0		21	25
TB22F1014	10	1/4	11,0	34,3	28,2		17	25
TB22F1038	10	3/8	12,0	35,8	28,2		21	25
TB22F1012	10	1/2	14,0	38,8	28,2		24	10
TB22F1214	12	1/4	11,0	37,0	29,5		21	25
TB22F1238	12	3/8	12,0	38,0	29,5		21	25
TB22F1212	12	1/2	14,0	40,5	29,5		24	10

NOTA: articolo di importazione - NOTE: imported item

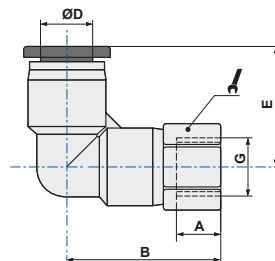

ART. TB22L

Gomito girevole cilindrico lungo
Swivel longer L male adaptor parallel

CODICE	ØD	G	ØB	H	L	L1		
TB22L04M5*	4	M5	11,0	3,5	34,5	19,0	10	25
TB22L0418	4	1/8	9,5	6,0	35,7	17,2	13	25
TB22L06M5*	6	M5	13,0	3,5	36,4	19,2	12	25
TB22L0618	6	1/8	11,5	6,0	35,7	20,8	13	25
TB22L0818	8	1/8	13,5	6,0	38,0	23,0	13	25
TB22L0814*	8	1/4	15,0	7,5	44,3	22,5	17	25

* = di importazione - imported

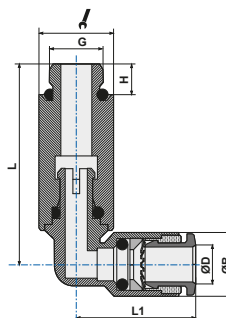

ART. TB22LC

Gomito girevole conico lungo
Swivel longer L male adaptor tapered

CODICE	ØD	G	A	B	ØC	E		
TB22LC0418	4	1/8	7,5	37,0	11,0	19,0	10	25
TB22LC0414	4	1/4	9,5	40,0	11,0	19,0	14	25
TB22LC0618	6	1/8	7,5	39,7	13,0	19,2	12	25
TB22LC0614	6	1/4	9,5	42,2	13,0	19,2	14	25
TB22LC0638	6	3/8	10,5	43,7	13,0	19,2	17	25
TB22LC0818	8	1/8	7,5	44,8	14,4	23,0	14	25
TB22LC0814	8	1/4	9,5	46,8	14,4	23,0	17	25
TB22LC0838	8	3/8	10,5	48,5	14,4	23,0	17	25
TB22LC1018	10	1/8	7,5	54,3	18,5	28,2	17	25
TB22LC1014	10	1/4	9,5	56,3	18,5	28,2	17	25
TB22LC1038	10	3/8	10,5	57,3	18,5	28,2	17	25
TB22LC1012	10	1/2	13,5	60,8	18,5	28,2	21	10
TB22LC1214	12	1/4	9,5	61,5	21,0	29,5	21	10
TB22LC1238	12	3/8	10,5	62,5	21,0	29,5	21	10
TB22LC1212	12	1/2	13,5	65,5	21,0	29,5	21	10

NOTA: articolo di importazione - NOTE: imported item

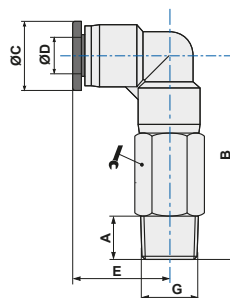

ART. TB23

 Y innestabile
Y connector

CODICE	ØD1	ØD2	ØE	ØB	A	L		
TB230400	4	4	2,40	9,5	19	33,0		50
TB230406	4	6	2,40	11,5	19	35,8		50
TB230600	6	6	2,60	11,5	23	38,6		50
TB230608	6	8	3,20	13,5	23	39,8		50
TB230800	8	8	2,75	16,5	27	42,5		50
TB230810	8	10	3,20	17,0	27	44,4		25
TB231000	10	10	4,30	20,0	34	50,8		25
TB231012*	10	12	4,30	20,0	34	50,8		10
TB231200	12	12	4,20	20,0	40	53,2		10

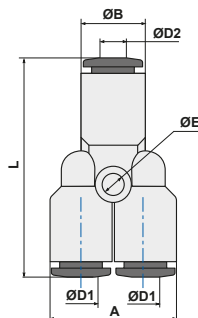
 * = di importazione - *imported*

ART. TB23L0

 Y innestabile
Y connector

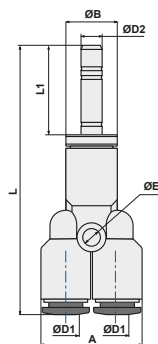
CODICE	ØD1	ØD2	ØB	A	ØE	L	L1	
TB2304L0	4	4	9,5	19	2,40	50,0	16,7	50
TB2306L0	6	6	11,5	23	2,60	58,1	19,5	50
TB2308L0	8	8	13,5	27	2,75	63,5	21,0	50
TB2310L0	10	10	17,0	34	4,30	74,8	24,0	25
TB2312L0	12	12	20,0	40	4,20	78,2	25,0	10

ART. TB23G

 Y innestabile filetto cilindrico con O-Ring
Y connector with swivel parallel male adapter

CODICE	ØD	G	ØA	ØB	H	A	L		
TB23G04M5*	4	M5	2,0	9,5	4,0	19,0	39,1	10	50
TB23G0418	4	1/8	3,0	9,5	5,5	19,0	20,5	13	50
TB23G0414	4	1/4	3,0	11,0	7,5	22,0	45,5	17	50
TB23G0438*	4	3/8	3,0	11,0	7,5	22,0	46,0	20	25
TB23G0618	6	1/8	5,0	11,5	5,5	23,0	34,8	13	50
TB23G0614	6	1/4	5,0	11,5	6,5	23,0	36,4	16	50
TB23G0638*	6	3/8	5,0	13,0	7,5	26,0	47,2	20	25
TB23G0818	8	1/8	7,0	13,5	5,5	27,0	37,5	13	50
TB23G0814	8	1/4	7,0	13,5	6,5	27,0	38,6	16	50
TB23G0838*	8	3/8	6,2	14,4	7,5	29,4	50,5	20	25
TB23G1014*	10	1/4	8,2	18,4	7,5	36,4	58,9	17	25
TB23G1038*	10	3/8	8,2	18,4	7,5	36,4	58,9	20	25
TB23G1012*	10	1/2	8,2	18,4	10	36,4	62,4	24	10
TB23G1214*	12	1/4	9,5	21,0	7,5	42,0	62,3	21	10
TB23G1238*	12	3/8	9,5	21,0	7,5	42,0	62,3	21	10
TB23G1212*	12	1/2	9,5	21,0	10	42,0	65,3	24	10

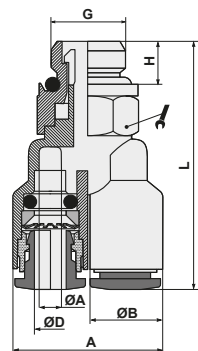
 * = di importazione - *imported*

ART. TB24

Y doppio innestabile
Double Y connector

CODICE	ØD1	ØD2	ØE	ØB	A max	L		
TB240400	4	4	3,2	9,5	20,2	34,5		25
TB240406	4	6	3,2	13,0	20,8	35,5		25
TB240408*	4	8	3,2	14,5	22,2	38,5		25
TB240600	6	6	3,2	11,5	23,9	39,6		25
TB240608*	6	8	3,2	13,5	26,15	41,8		25
TB240800*	8	8	3,5	15,0	28,0	42,0		25
TB240810	8	10	3,2	17,0	28,0	46,5		25

* = di importazione - imported

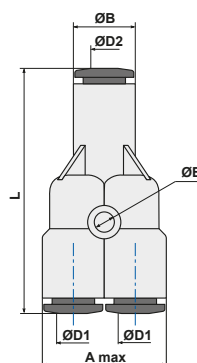

ART. TB24L0

Y doppio innestabile
Double Y connector

CODICE	ØD1	ØD2	ØE	ØB	A	L	L1	
TB2404L0	4	4	2,40	9,5	19	51,2	16,7	25
TB2406L0	6	6	2,60	11,5	23	59,1	19,5	25
TB2408L0	8	8	2,75	13,5	27	67,5	21,0	25

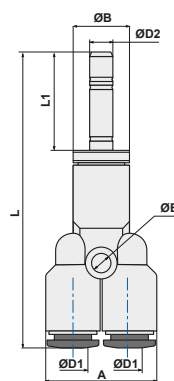

ART. TB33

Doppio anello semplice girevole con asta
Swivel double banjo stem

CODICE	ØD	G	ØA	H	L1	L	⊙	⌘	▮
TB3304M5	4	M5	2,0	4,0	28,0	19,5	2,5	14	22
TB330418	4	1/8	5,5	5,5	43,3	21,1	3	14	25
TB330618	6	1/8	5,5	5,5	43,3	24,3	3	14	25
TB330614	6	1/4	7,8	6,5	50,0	25,5	4	18	25
TB330818	8	1/8	5,5	5,5	43,3	24,8	3	14	25
TB330814	8	1/4	7,8	6,5	50,0	26,5	4	18	25
TB331014	10	1/4	7,8	6,5	50,0	28,4	4	18	25

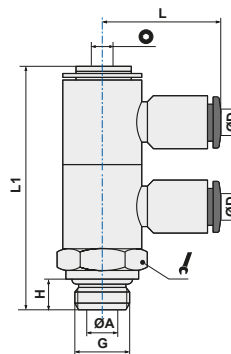

ART. TB33B

Doppio anello due vie girevole con asta
Double branch universal male L

CODICE	ØD	G	ØA	H	L1	L	⊙	⌘	▮
TB33B04M5	4	M5	2,0	4,0	28,0	19,5	2,5	14	10
TB33B0618	6	1/8	5,5	5,5	43,3	24,3	3	14	10
TB33B0814	8	1/4	7,8	6,5	50,0	26,5	4	18	10

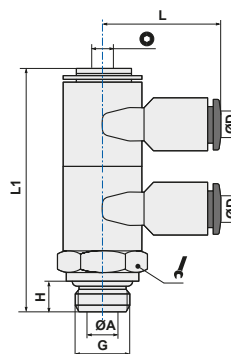

ART. TB34

 Triplo anello semplice girevole con asta
Swivel triple banjo stem

CODICE	ØD	G	ØA	H	L1	L	Ø	Icona	Icona
TB340418	4	1/8	5,5	5,5	58,4	21,1	3	14	10
TB340618	6	1/8	5,5	5,5	58,4	24,3	3	14	10
TB340818	8	1/8	5,5	5,5	58,4	24,8	3	14	10
TB340614	6	1/4	7,8	6,5	67	25,5	4	18	10
TB340814	8	1/4	7,8	6,5	67	26,5	4	18	10
TB341014	10	1/4	7,8	6,5	67	28,4	4	18	10

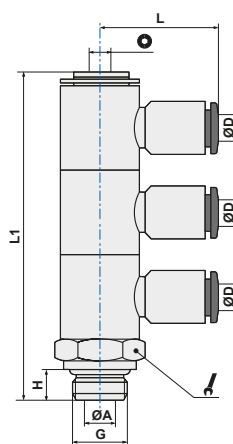
ART. TB34B

 Triplo anello due vie girevole con asta
Triple branch universal male L

CODICE	ØD	G	ØA	H	L1	L	Ø	Icona	Icona
TB34B0618	6	1/8	5,5	5,5	58,4	24,3	3	14	10
TB34B0814	8	1/4	7,8	6,5	67	26,5	4	18	10

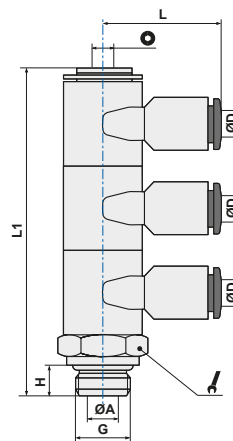
ART. TB90

 Tappo femmina
Tube Blanking Cap

CODICE	ØD	ØD1	L				Icona
TB900400	4	11,5	17,5				100
TB900600	6	13,5	17,7				100
TB900800	8	15	21,3				100
TB901000	10	19	25				50
TB901200	12	21,5	26				50

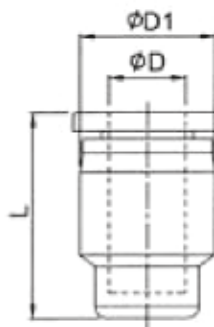
 Adattabile a tutti i raccordi della serie Tecno-RAP
Suitable for all Tecno-RAP fitting series

 Di importazione
Import

BREVE DESCRIZIONE

I raccordi automatici della nostra serie TECNORAP sono realizzati in Italia, a garanzia di elevati standard di qualità secondo le normative ISO di riferimento, e rispondono alle seguenti specifiche tecniche e applicative.

SHORT DESCRIPTION

The TECNORAP series push-in fittings are produced in Italy according to the reference ISO norms as warranty of high quality level and answer to the followings technical specifications and applications.

SCHEDA TECNICA TECHNICAL SHEET

FLUIDI UTILIZZABILI <i>EMPLOYABLE FLUIDS</i>		Aria compressa (per altri fluidi contattare il nostro Ufficio Tecnico) <i>Compressed air (for different fluid pls contact our Technical Dept.)</i>
APPLICAZIONI <i>APPLICATIONS</i>		Pneumatica, idraulica a bassa pressione, secondo normativa DIN 3861-3870. Idonei al funzionamento con il vuoto. <i>Pneumatic circuits, low pressure hydraulic applications, according to DIN 3861-3870 norms. Suitable for vacuum applications.</i>
TUBI CONSIGLIATI <i>SUGGESTED TUBES</i>		TPU (Poliuretano), PA11/PA12 (Poliammide), TPE (Polietilene), TCO (Copoliestere) <i>TPU (Polyurethane), PA11/PA12 (Polyamide), TPE (Polyethylene), TCO (Copolyester)</i>
TOLLERANZE TUBI <i>TUBES TOLERANCES</i>		Diam. da 4 a 10 mm +/- 0,05 Diam. da 12 mm +/- 0,1 <i>Diam. between 4 and 10 mm +/- 0,05 Diam. from 12 mm +/- 0,1</i>
GRADO DI PROTEZIONE <i>INGRESS PROTECTION</i>		"IP 68"
TEMPERATURE E PRESSIONI <i>TEMPERATURE AND PRESSURE</i>	VALORI LIMITE CONSIGLIATI <i>RECOMMENDED LIMIT VALUES</i>	Le temperature e le pressioni dipendono generalmente dalle caratteristiche del tubo impiegato, e comunque si suggerisce di non superare i 12 bar e temperature comprese fra -20°C e +50°C. <i>Temperatures and pressures usually depend by the technical features of the employed tubes, anyway it is suggested a limit working pressure of 12 bar and a temperature range between -20°C and +50°C</i>
	DATI TECNICI DI PROVA <i>TECHNICAL TESTING DATA</i>	A pag. 64 sono riportati i dati di resistenza a trazione e i valori limite di utilizzo (Pressione e Temperature) relativi ai principali tubi commerciali. <i>At page 64 are indicated the load traction resistance values and the main working and breaking limit (Pressure and Temperature) of the main commercial tubing.</i>
	NOTA <i>NOTE</i>	Per dati più puntuali consultare il catalogo tecnico del proprio fornitore di tubi. <i>For more complete informations pls read the technical catalogue of your tube supplier.</i>
FILETTATURE <i>THREAD TYPE</i>		BSP cilindrica UNI-ISO 228; BSP conica UNI-ISO 7; Metrica ISO/R 262. <i>BSP parallel UNI-ISO 228; BSP tapered UNI-ISO 7; Metric ISO/R 262</i>
MATERIALI <i>MATERIALS</i>	corpo, spintore, distanziale, sottomolla <i>body, sleeve, collar and back ring</i>	POM copolimero ISO1043-1 <i>POM copolymer ISO1043-1</i>
	corpi raccordi T01 e basi girevoli serie T22T <i>fittings body T01 and swivel bases T22T series</i>	IXEF tecnopolimero caricato in vetro <i>IXEF technopolymer glass-fiber reinforced</i>
	astine e basi girevoli <i>swivel stems and bases</i>	Ottone UNI EN 12164 CW614N <i>Brass UNI EN 12164 CW614N</i>
	pinza <i>spring</i>	Acciaio Inox AISI 301 austenitico <i>Stainless steel AISI 301 austenitic</i>
	guarnizioni tenuta <i>seals</i>	NBR 70 DWGV-EN549 UL157 <i>NBR 70 DWGV-EN549 UL157</i>

INFORMAZIONI TECNICHE AGGIUNTIVE

Ogni lotto della serie Tecno-RAP viene sottoposto a controlli cosiddetti "rompilotto" durante tutto il ciclo produttivo, che comprendono, oltre all'osservazione estetica, la verifica di funzionalità e di eventuali perdite, un test in pressione a 8 bar per verificarne la conformità anche in condizioni di utilizzo nominali. Successivamente viene eseguito un test a campione di rottura (simulazione scoppio a 50 bar di pressione) con una macchina dedicata che sollecita il raccordo a trazione. Di seguito viene indicata la forza minima di strappo (in Newton) ammessa per ogni diametro:

Diam. tubo <i>Tube diam.</i>	Forza di strappo <i>Breaking load</i>
Ø4	63 N
Ø6	141 N
Ø8	251 N
Ø10	393 N
Ø12	566 N

Nota importante:

I valori indicati si riferiscono alla tenuta della pinza di aggiraffaggio, "core part" sia del raccordo Tecno-RAP in tecnopolimero, che del RAP in ottone, per cui omogenei. I valori di rottura sperimentali misurati sono stati, in base al diametro, anche da 1,2 a 2,5 volte superiori.

Informazioni complementari sulle temperature di utilizzo:

Pressione di esercizio e pressione di scoppio (bar) alle diverse temperature Working pressure and breaking pressure (bar) at different temperatures						
Esempio Example	T-20°C	T-20°C	T+23°C	T+23°C	T+60°C	T+60°C
Tube 6x4 colored	P esercizio bar working P bar	P scoppio bar breaking P bar	P esercizio bar working P bar	P scoppio bar breaking P bar	P esercizio bar working P bar	P scoppio bar breaking P bar
TPU	18,7	74,8	10,0	40,0	5,2	20,8
PA11	37,4	149,6	20,0	80,0	10,4	41,6
PA12	48,6	168,3	26,0	90,0	10,4	36,0
PE	18,7	74,8	10,0	40,0	5,0	20,0

Tutte le necessarie valutazioni sull'utilizzo dei raccordi in condizioni di esercizio differenti da quelle suggerite nella scheda tecnica iniziale debbono anche tenere conto, con riferimento alle temperature, dei dati nominali relativi al tubo utilizzato e del limite imposto dal componente più critico.

SERIE TECNORAP: -20°+50° • SERIE RAP : -20° +70°
 SERIE OT: -20° + 80° • SERIE OV : -20° +150°
 SERIE SS:-20° +120°

ADDITIONAL TECHNICAL INFORMATION

Each Tecno-RAP production batch is tested according to severe cyclics "lot breaker" controls along all the production period, which include shape observation, leakage verification, functionality, at the working pressure of 8 bar.

Then all samples taken from the lot are tested by a traction machine which simulate a breaking pressure of 50 bar.

Here below are indicated the traction loads (in Newton) for each size:

Important note:

The values refer to the resistance of the crimping gripper, "core part" of both fittings, the technopolymer Tecno-RAP and the brass RAP, whereby homogeneous. The breaking experimental values measured, according to the diameter, were from 1.2 to 2.5 times higher.

Additional information regarding the working temperatures:

Further to all the necessary assessments on the use of the fittings in operating conditions different from how suggested in the initial technical sheet must be considered, with reference to temperatures, the nominal data regarding the type of the used tube and the limit imposed by the most critical component.

*SERIES TECNORAP: -20°+50° • SERIES RAP : -20° +70°
 SERIES OT: -20° + 80° • SERIES OV : -20° +150°
 SERIES SS:-20° +120°*